

Easy Energy
Easy Life

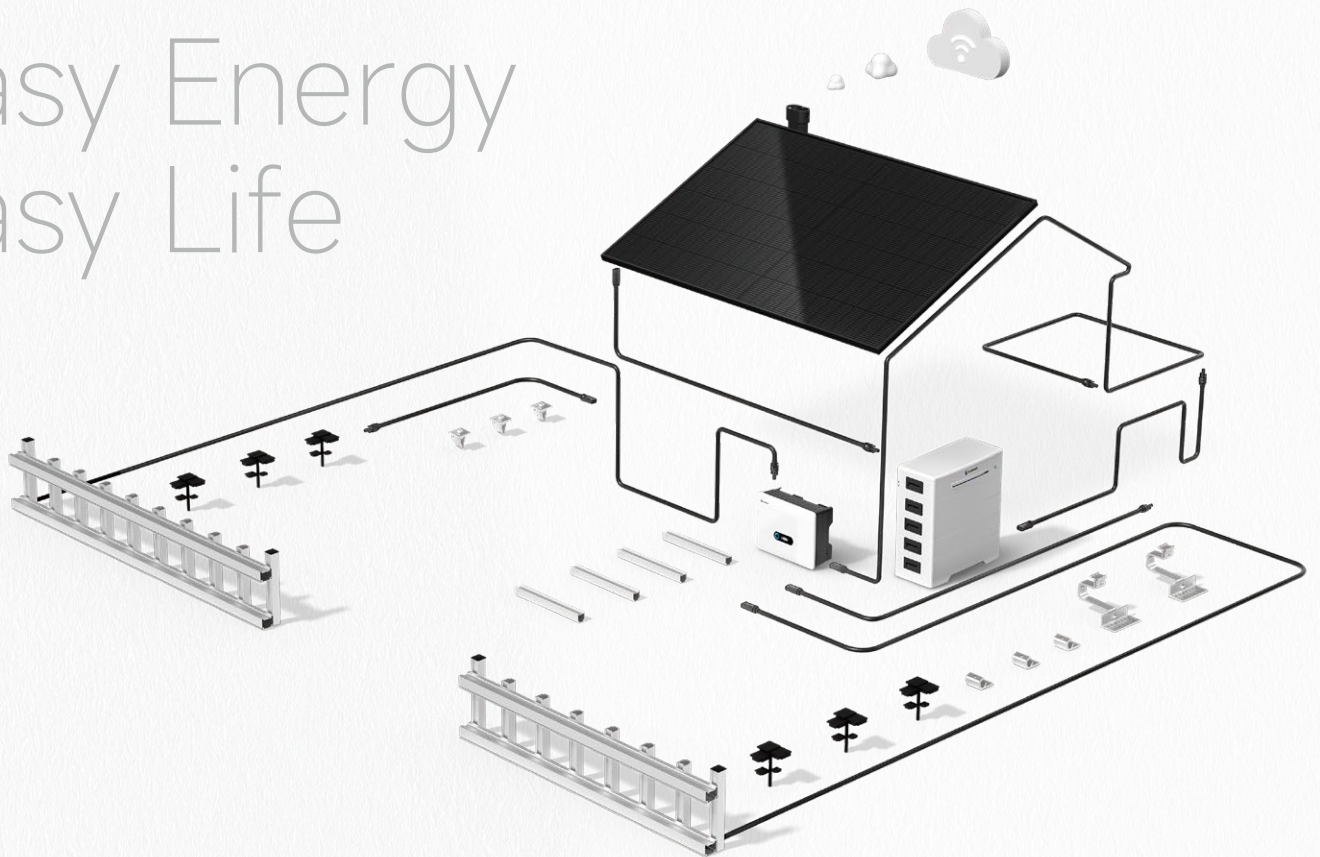

 **Share-Home**

Smart Solar System User Manual



Easy Energy Easy Life

Thank you for choosing iShare-Home Smart Solar System!

This installation manual contains important electrical and mechanical installation information that should be known before you install iShare-Home Smart Solar System. In addition, the manual contains some other security information that you must know.

Copyright is owned by Slenergy Technology (A.H.) Co., Ltd. (hereinafter referred to as Slenergy) and no content of this document can be reproduced or disseminated in any form or manner without Slenergy's prior written consent.

This installation manual does not have the meaning of any warranty, either express or implied. There is no provision for the compensation scheme for the loss, equipment damage or other expenses directly caused or related to the installation, operation, use or maintenance of the system equipment. Slenergy is not liable for any patent infringement or third-party rights arising from the use of the system. Slenergy reserves the right to change the Product specification and this manual without prior notice.

Failure by the customer that not follow the requirements listed in this manual during the installation of the system equipment will result in the failure of the limited warranty of the product provided to the customer. At the same time, the Suggestions in this manual are to improve the safety of photovoltaic power generation system during the installation process, which has been tested and experienced. Please provide this manual to installers or owners of PV systems for reference and advise them of all safety, operation, maintenance requirements and recommendations

Slenergy Technology Co. S.L.

Website

www.slenergy.com

Address

Avenida de Europa 26, edificio atica V. 2ºF, 28224 Pozuelo de Alarcón, Madrid

Technical support email

service@slenergy.com

About This Manual

Purpose

This manual introduces the installation, electrical connection, debugging, use, maintenance and troubleshooting of Slenergy. Home photovoltaic power generation system. Before installation and operation, please read through this document to understand the security information and familiarize with the system functions and features.

Note

The use of energy storage function are not mentioned in the main text of this manual. This section will be optimized in later stage.

Reader

The readers of this manual are:

- System installer
- System user

This manual is applicable to electrical installers with professional qualifications and end-users, who should have the following skills:

- 1 Training for installation and commissioning of the electrical system, as well as dealing with hazards.
- 2 Knowledge of the manual and other related documents.
- 3 Knowledge of the local regulations and directives.

Symbols

Definition of the symbols in this manual are as the following:



Indicates a hazard with a high level of risk which, if not avoided, will result in death or serious injury.



Indicates a hazard with a medium level of risk which, if not avoided, could result in death or serious injury.



Indicates a hazard with a low level of risk which, if not avoided, could result in minor or moderate injury.



Indicates a situation that, if not avoided, could result in equipment or property damage, data loss, equipment performance degradation.



Indicates additional information, emphasized contents or tips that may be helpful, e.g., to help you solve problems or save time.



This symbol allows the operator to pay attention to the protection of personal safety against electricity prohibited matters.



If fire, switch off the breaker on DC side and stay away from battery.



The battery cannot be disposed of with household waste.



This symbol identifies the precautions or instructions that may pose a risk to the safety of the user or cause significant hardware damage if not properly operated.

Contents

	About this Manual	2
1	System Introduction	8
	1.1 System schematics and wiring diagram	9
	1.2 Equipment List	10
	1.3 Technical data of PV module	11
	1.3.1 Modules identification	11
	1.3.2 Technical data of PV module	12
	1.4 Technical data of inverter	13
	1.4.1 Hybrid Inverter 3~8kW	13
	1.5 Technical data of Battery	15
	1.6 Technical data of mounting system	16
	1.7 Technical data of iBox	17
	1.8 Technical data of cable	18
	1.8.1 Cable set	18
	1.8.2 DC Cable	19
	1.8.3 AC Cable	20
	1.8.4 Earthing Cable	21
2	Safety	22
	Setting of Warning Sign for Safety	23
	Measuring Equipment	23
	Moisture Protection	23
	2.1 Safety notice	24
	PV modules	25
	Inverter	25
	Battery	25
	Mounting Structure	26
	iBox	27
	2.2 Disclaimer	28
	2.3 Operator requirements	29
	2.4 Protecting Labels	29
	2.5 Operation after Power Failure	29
	2.6 Fire Safety	29
	PV Module	29
	Inverter	29
	Battery	29
	2.7 Grounding	30
	2.7.1 PV module grounding	30
	2.7.2 Mounting system grounding	30

2.7.3 Inverter grounding	31
2.7.4 Battery grounding	31
2.7.5 iBox grounding	31
3 Transportation and storage	32
3.1 Storage and transportation of PV modules	33
3.1.1 Transportation and handling	33
3.1.2 Storage	33
3.1.3 Unpacking	34
3.2 Storage and transportation of inverter	35
3.3 Storage and transportation of Mounting system	35
3.4 Storage and transportation of Battery	35
3.4.1 Storage requirement	35
3.5 Transportation and storage of iBox	36
3.5.1 Storage environment	36
4 Equipment installation	37
4.1 Checking Before Installation	38
4.1.1 Installation tools	38
4.1.2 Check before the PV module installation	39
4.1.3 Checking Before iBox Installation	40
4.1.4 Checking before Mounting system Installation	42
4.1.5 Checking before inverter Installation	43
4.1.6 Checking before battery installation	45
4.2 Installation Mounting system and PV module installation	46
4.2.1 Mounting angle	46
4.2.2 Installation method introduction	47
4.3 Installation of mounting structure	49
4.3.1 Installation Precaution	49
4.3.2 Installation of Tile Hook/Hanger Bolt	49
4.3.3 Installation of Rail	53
4.3.4 Installation of Rail Splice	53
4.3.5 Installation of PV Modules	54
4.3.6 Installation of Grounding Lug	55
4.3.7 Installation of Rail Cap	55
4.3.8 Installation Diagram	55
4.4 Inverter installation	57
4.4.1 Determining the Installation Position	57
4.4.2 Mounting the Inverter	58
4.4.3 External Ground Connection	59
4.5 Battery installation	60

4.5.1	Location Requirements	60
4.5.2	Mounting Battery	60
4.5.3	Slave Battery Installation	61
4.5.4	Install the Battery Control Box	61
4.5.5	Fix the Product	62
4.6	iBox installation	63
4.6.1	iBox installation	63
5	Electrical Connections	65
5.1	DC Electrical connections	66
5.1.1	Electrical connections of PV modules	66
5.1.2	Assembling the PV Connector	67
5.2	AC Inverter electrical connections	70
5.2.1	Electrical Wiring Diagram	71
5.2.2	AC Connection	72
5.2.3	Monitoring Device Installation	73
5.5	Communication Connection	73
5.5.1	Meter and CT Connection	73
5.5.2	Inverter Communication	76
5.5.3	EMS Communication	83
5.6	Power Cable of the Battery Connection	83
5.6.1	The following principles must be considered when making battery connection	83
5.7	Battery electrical connections	84
6	Commissioning	85
6.1	Check Before Power-On	86
6.2	App Preparation	86
6.3	Inspection Before Commissioning	86
6.4	Commissioning Procedure	87
6.5	Stop the Inverter	87
7	Operation	89
7.1.1	Main Window	89
7.2	General Setting	90
7.3	Advanced Setting	91
7.4	Country Code (Safety Code) Setting	94
7.5	Auto-Test	94
7.6	Reactive Power	96
7.7	Operation mode	98

8	Monitoring	100
	8.1 Inverter Monitoring	101
	8.1.1 Monitoring Device	101
	8.1.2 Cloud monitoring App	101
	8.1.3 Local configuration App	101
	8.2 Battery LED indication	102
9	Maintenance & Troubleshooting	103
	9.1 Maintenance and troubleshooting of PV modules	104
	9.1.1 Visual inspection	104
	9.1.2 Connector and cable inspection	104
	9.1.3 Cleaning	105
	9.1.4 Troubleshooting	105
	9.2 Maintenance and troubleshooting of inverter	106
	9.2.1 Maintenance of inverter	106
	9.2.2 Troubleshooting of inverter	107
	9.3 Maintenance and troubleshooting of Battery	109
	9.3.1 Maintenance of electrical components	109
	9.3.2 Battery Maintenance	109
	9.4 Maintenance and troubleshooting of Mounting structure	110

System Introduction



1.1 System schematics and wiring diagram

The system in this manual is composed of PV module, inverter, battery, iBox, mounting structure and cable sets, and can convert the DC power generated by the PV system into 230Vac single-phase AC power via the inverter. The system is connected to the original distribution box of the user. It is a smart power generation system that meets the local grid connection needs and controls the feed to the grid. The iBox in this manual works in an iShare-home PV power generation system. The basic variant of iShare-home residential PV power generation system is composed of PV modules, inverter, iBox, mounting structure and cables, Figures 1.1-1 and 1.1-2 respectively show the schematics and wiring diagram of the basic variant of iShare-home system.

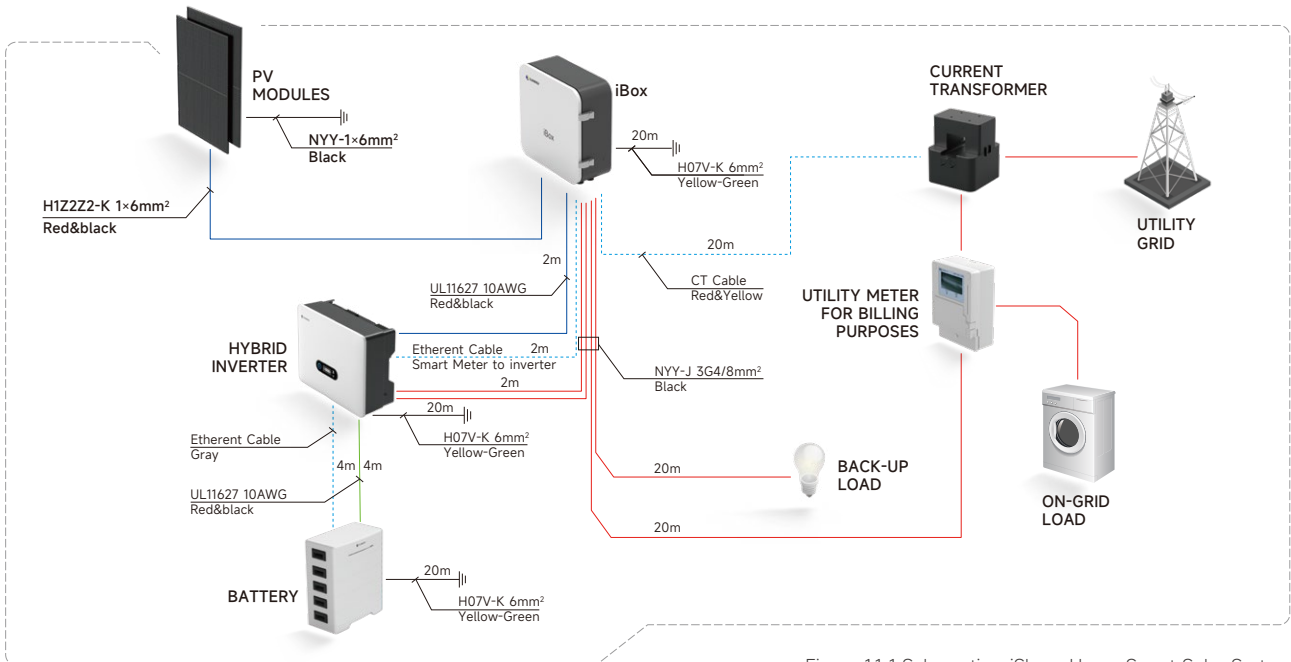

Figure 1.1-1 Schematics: iShare-Home Smart Solar System

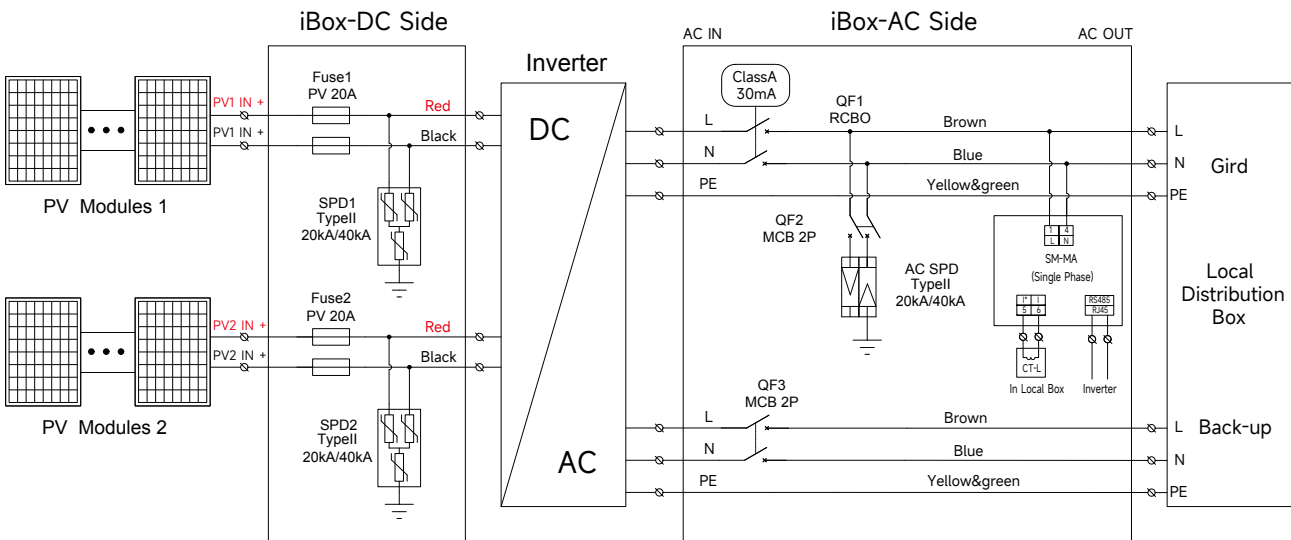

Figure 1.1.2 iBox Topography

1.2 Equipment List

System configuration is as the following:

Model	iShare-Home 3kW	iShare-Home 4.2kW	iShare-Home 6kW	iShare-Home 8kW
System capacity	3	4.2	6	8
No. PV Modules (pcs)/425W	6/8	10/12	14/16/18	20/22/24
Effective Roof Area Approx.	13m ² ~17m ²	21m ² ~26m ²	30m ² ~39m ²	43m ² ~52m ²
Inverter	SL-D3KTL-H30	SL-D4.2KTL-H30	SL-D6KTL-H30	SL-D8KTL-H30
Battery	SL-BH-2-5 ~ SL-BH-8-20			
Cable set	DC Cable: H1Z2Z2-K 1x6mm ² ; UL 11627 10AWG			
	AC Cable: NYY-J 3G4mm ² /8mm ²			
	Earthing Cable: NYY-1x6mm ² ; H07V-K 6mm ²			
	Ethernet Cable: UTP CAT5e			
	Connectors			
Mounting structure set	Rail, hook kit/hanger bolt kit, rail connector, mid-clamp, end-clamp, earthing lug and other accessories			
iBox	SL-BH5KL		SL-BH10KL	
Power Generation Estimates (Italy)	9~12kWh/day 3185~4246kWh/year	15~17kWh/day 5308~6369kWh/year	20~26kWh/day 7431~9554kWh/year	29~35kWh/day 10615~12738kWh/year
Power Generation Estimates (Spain)	10~13kWh/day 3680~4907kWh/year	17~20kWh/day 6134~7360kWh/year	24~30kWh/day 8587~11040kWh/year	34~40kWh/day 12267~14721kWh/year
Cloud & App	1 set			

The power generation is calculated based on Rome, Italy. The annual peak sunshine hours are 1523h.
 The power generation is calculated based on Madrid, Spain. The annual peak sunshine hours are 1760h.
 Each kWh generated reduces 0.997kg of CO₂.

1.3 Technical data of PV module

1.3.1 Modules Identification

3 labels on the modules contain information below:

- 1 Nameplate: product type, rated power, rated current, rated voltage, open circuit voltage, short circuit current under testing conditions, certification indicator, maximum system voltage, etc.
- 2 Current classification label: Rated working current (H indicates High, M indicates Medium, L indicates Low).
- 3 Serial Number label: A unique serial number which is laminated inside the module permanently which can be found in the front of the module. There is another same serial number beside the module nameplate.

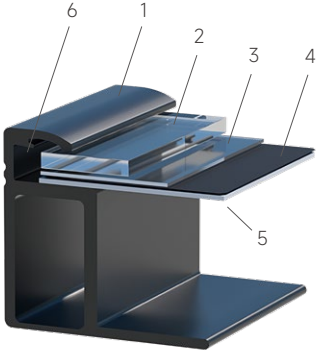
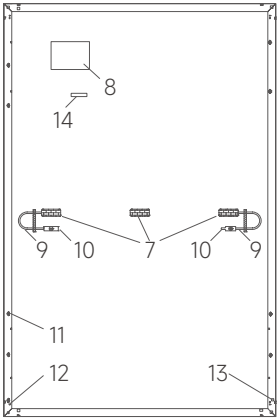

Figure 1.3.1-1 Regular modules Mechanical drawing

1 Frame	2 Glass	3 EVA	4 Solar Cell
5 Backsheet	6 Silica Gel	7 Junction Box	8 Name Plate
9 Cable	10 Connector	11 Mounting Hole	12 Grounding Hole
13 Drain Hole	14 Bar Code		

1.3.2 Technical Data of PV Module

Items Specifications	
Module Number	SL-108NA-425
Electrical Characteristics	
Maximum Power (Pmax/W)	425
Open Circuit Voltage (Voc/V)	37.83
Short Circuit Current (Isc/A)	14.05
Voltage at Maximum Power (Vmp/V)	31.94
Current at Maximum Power (Imp/A)	13.31
Module Efficiency (%)	21.76
Mechanical Parameters	
Cell Orientation	108 (6*18)
Junction Box	IP68, three diodes
Output Cable	4mm ² , 1200mm in length
Glass	Single glass, 3.2mm coated tempered glass
Frame	Anodized aluminum alloy frame
Weight (kg)	21.5
Dimension (mm)	1722*1134*30
Packaging	36pcs per pallet 216pcs per 20'GP 936pcs per 40'HQ
Operating Parameters	
Operational Temperature (°C)	-40 ~ +85
Power Output Tolerance (W)	0 ~ +5
Voc and Isc Tolerance	±3%
Maximum System Voltage (V)	DC1500 (IEC/UL)
Maximum Series Fuse Rating (A)	25
Nominal Operating Cell Temperature (°C)	45±2
Safety Protection Class	Class II
Temperature Ratings (STC)	
Temperature Coefficient of Isc	+0.050%/°C
Temperature Coefficient of Voc	-0.263%/°C
Temperature Coefficient of Pmax	-0.343%/°C
Mechanical Loading	
Front Side Maximum Static Loading (Pa)	5400
Rear Side Maximum Static Loading (Pa)	2400
Hailstone Test	25mm Hailstone at the speed of 23m/s

STC (Standard Testing Conditions) : Irradiance 1000W/m², Cell Temperature 25°C, Spectra at AM1.5

1.4 Technical data of inverter

1.4.1 Hybrid Inverter 3~8kW

Model	SL-D3KTL-H30	SL-D4.2KTL-H30	SL-D6KTL-H30	SL-D8KTL-H30
PV Input				
Recommended Max. input power [kW]	4.8	6.72	9.6	12.8
Start-up voltage [V]	80	80	80	80
Max. DC input voltage* [V]	600	600	600	600
Rated DC input voltage [V]	360	360	360	360
MPPT voltage range**[V]	100-550	100-550	100-550	100-550
No. of MPP trackers	1	2	2	2
No.of DC inputs per MPPT	1	1/1	1/1	1/1
Max. input current [A]	15	15/15	15/15	15/15
Max short-circuit current [A]	20	20/20	20/20	20/20
Battery Side				
Battery type	Lithium Battery (with BMS)			
Battery voltage range [V]	85~450			
Maximum charging/discharging current [A]	30/30			
Grid Side				
Rated output power [kW]	3	4.2	6	8
Max. output apparent power [kVA]	3.3	4.6	6.6	8
Max. input apparent power*** [kVA]	6	8.4	10	12
Max. charging power of battery [kW]	3	4.2	6	8
Rated AC voltage	L/N/PE:220/230/240V			
Rated AC frequency [Hz]	50/60	50/60	50/60	50/60
Max. output current [A]	15	21	28.7	36.3
Power factor	0.8 leading ... 0.8 lagging			
Max. total harmonic distortion	<0.3% @Rated output power			
DCI	<0.5%In	<0.5%In	<0.5%In	<0.5%In
Back-up side				
Rated output power [kW]	3	4.2	6	8
Max. output apparent power [kVA]	3.3	4.6	6.6	8
Max. output current [A]	15	21	28.7	36.3
UPS switching time	<10ms	<10ms	<10ms	<10ms
Rated output voltage	L/N/PE:220/230/240V			
Rated output frequency [Hz]	50/60	50/60	50/60	50/60
Peak output apparent power (kVA)****	3.9, 60s	5.5, 60s	9, 60s	10, 60s
Voltage harmonic distortion	<3% @Linear load			
Efficiency				
Max. Efficiency	97.60%	97.60%	97.60%	97.60%
European efficiency	97.00%	97.00%	97.00%	97.00%
Warranty	10 years			



Model	SL-D3KTL-H30	SL-D4.2KTL-H30	SL-D6KTL-H30	SL-D8KTL-H30
-------	--------------	----------------	--------------	--------------

Protection	
DC reverse polarity protection	Integrated
Battery input reverser connection protection	Integrated
Insulation resistance protection	Integrated
Surge protection	Integrated
Over-temperature protection	Integrated
Residual current protection	Integrated
Islanding protection	Integrated
AC over-voltage protection	Integrated
Overload protection	Integrated
AC short-circuit protection	Integrated
General Data	
Over voltage category	PV: II Main: III
Dimensions [W×H×D mm]	534×418×210
Weight [kg]	27
Protection Degree	IP65
Standby self-consumption [W]	<15
Topology	Transformerless
Operating Temperature Range [°C]	-30~60
Relative Humidity	0~100%
Operating Altitude	3000 (>3000m derating)
Cooling	Natural Convection
Noise Level [dB]	<25
Display	OLED&LED
Communication	CAN, RS485, WiFi/LAN (Optional)

* Max. operating DC voltage is 550V, max. withstanding DC voltage is 600V

**The maximum MPPT voltage and operating voltage upper limit will be reduced to 520 V when inverter connects and works with battery

*** Max apparent power from the grid means the maximum power imported from the utility grid used to satisfy the backup loads and charge the battery.

**** The output power will exceed the rated value only when the power in the PV array is sufficient, and the duration of the overload is related to the overload power

1) G98: 3.68kVA;

2) G98: 16.00A;

3) AS 4777.2: 5.0kW, VDE-AR-N 4105: 4.6kW;

4) AS 4777.2: 5.0kVA, VDE-AR-N 4105: 4.60kVA, C10/11: 5.0kVA;

5) AS 4777.2: 21.7A, VDE-AR-N 4105: 21.0A, C10/11: 21.7A.

1.5 Technical data of Battery









Model	SL-BH-2-5	SL-BH-3-7	SL-BH-4-10	SL-BH-5-12
Electrical Parameters				
No. of series battery	2	3	4	5
Rated energy [kWh]	5.12	7.68	10.24	12.8
Usable energy [kWh]	4.6	6	9.2	11.52
Rated voltage [V]	102.4	153.6	204.8	256
Voltage range [V]	89.6-115.2	134.4~172.8	179.2~230.4	224~288
Rated capacity [Ah]	50			
Charge current [A]	25(Recommended)/50(MAX)			
Discharge current [A]	25(Recommended)/50(MAX)			
Cycle times	80% DOD, cycles >6000, residual capacity >70%			
Communication	RS485/RS232/CAN 2.0			
Protection function	Over voltage/Under voltage/Over temperature/Low temperature/Over current/Short circuit			
Size [WxDxH, mm]	710x320x502	710x320x639	710x320x776	710x320x913
Weight [kg]	85.2	118	150.8	183.6
Working Conditions				
Installation	Indoor			
Working temperature	-10°C~50°C			
Optimum working temperature	20°C~60°C			
Storage temperature	-30°C~60°C			
Protection degree	IP54			
Humidity	5%-95%			
Altitude [m]	≤2000			
Cooling	Natural Convection			
Certificate	CE, UN38.3, MSDS, CB/EMC, IP			
Model	SL-BH-6-15	SL-BH-7-17	SL-BH-8-20	
Electrical Parameters				
No. of series battery	6	7	8	
Rated energy [kWh]	15.36	17.92	20.48	
Usable energy [kWh]	13.8	16.13	18.4	
Rated voltage [V]	307.2	358.4	409.6	
Voltage range [V]	268.8~345.6	313.6~403.2	358.4~460.8	
Rated capacity [Ah]	50			
Charge current [A]	25(Recommended)/50(MAX)			
Discharge current [A]	25(Recommended)/50(MAX)			
Cycle times	80% DOD, cycles >6000, residual capacity >70%			
Communication	RS485/RS232/CAN 2.0			
Protection function	Over voltage/Under voltage/Over temperature/Low temperature/Over current/Short circuit			
Size [WxDxH, mm]	710x320x1050	710x320x1187	710x320x1324	
Weight [kg]	216.4	249.2	282	



Model	SL-BH-2-5	SL-BH-3-7	SL-BH-4-10	SL-BH-5-12
Working Conditions				
Installation	Indoor			
Working temperature	-10°C~50°C			
Optimum working temperature	20°C~60°C			
Storage temperature	-30°C~60°C			
Protection degree	IP54			
Humidity	5%-95%			
Altitude [m]	≤2000			
Cooling	Natural			
Certificate	CE, UN38.3, MSDS, CB/EMC, IP			
Warranty	10 years			

1.6 Technical data of mounting system

Product Name	Solar Mounting System	Design Standard	EN 1991-1-1: 2002
Building Type	Pitched Roof		UNE EN1991-1-3-2018
Tile Type	Concrete Tile, Clay Tile, Slate Tile		UNE EN 1991-1-4-2018
Tilt Angle	15-60°	Main Material	AL6005-T6(Anodized)
Wind Load	0.52KN/m ²	Fastener	SUS304 & Zinc-Nickel Alloy Electroplated Steel
Snow Load	0.6KN/m ²	Small Components	AL6005-T6(Anodized)
Applicable Solar Module	Framed	Color	Silver and black
Panel Layout	Portrait or Landscape	Certificate	TUV

	Item No.	Description	Material		Item No.	Description	Material
	51211786A	Rail H40	AL6005-T6		51230026R	End cap	Silica Gel
	31220174A	Rail Splice	AL6005-T6		55110091	Cable clip	SUS304
	31101261A	Universal clamp kit	AL6005-T6		31510043A	Grounding Lug	AL6005-T6
	31101262A	Tile hook	AL6005-T6		51500011F	Earthing clip	SUS304
	31101262A	Hanger Bolt	AL6005-T6				

1.7 Technical data of iBox

iBox	SL-BH5KL	SL-BH10KL
DC Side		
Max input/output voltage [V]	600	600
Max input/output current [A]	15	15
AC Side		
Rated input/output voltage	230V	230
Max input/output current [A]	25	45.4
Rated Frequency [Hz]	50/60	50/60
Working environment		
Operation Temp.	-10°C~+50°C	-10°C~+50°C
Relative Hum.	98% non-condensation	98% non-condensation
Altitudes [m]	≤2000	≤2000
P Degree	IP54	IP54
Installation methods	Indoor, Hanging	Indoor, Hanging
Standards		IEC61439-1 IEC61439-2
Certifications	CE	CE
Dimensions(mm) W×H×D:	400×400×160mm	400×450×160
Weight [kg]	16	17

1.8 Technical data of cable

1.8.1 Cable set

No.	Name	Specification	From	To	Remark	Accessory bag	Length (m)
1	PV DC Cable	H1Z2Z2-K 1×6mm ²	PV Modules	iBox PV input connector	Cable terminals are made and installed on site	MC4 Connector	20~60m*2
2	iBox to Inverter DC Cable	UL 11627 10AWG	iBox DC output	Inverter DC Input	Cable terminals are prefabricated and installed at the factory	-	2m*2
3	Inverter to Battery DC Cable	UL 11627 10AWG	Inverter Battery connector	Battery output connector	Both side terminals are prefabricated and installed at the factory	-	4m*2
4	Inverter to iBox AC Cable (On grid)	NYY-J 3G4mm ² /8mm ²	Inverter AC output connector	iBox AC input connector	Cable terminals are prefabricated and installed at the factory	-	2m
5	Inverter to iBox AC Cable (Backup)	NYY-J 3G4mm ² /8mm ²	Inverter AC Backup output connector	iBox AC Backup input connector	Cable terminals are prefabricated and installed at the factory	-	2m
6	iBox to Utility Distribution Box (On grid)	NYY-J BVR-1×6mm ²	iBox AC Output connector	Utility Distribution Box	iBox side terminal is prefabricated and installed at the factory	-	20m
7	iBox to Utility Distribution Box (Backup)	NYY-J 3G4mm ² /8mm ²	iBox AC Backup Output connector	Utility Distribution Box	iBox side terminal is prefabricated and installed at the factory	-	20m
8	Inverter PE	H07V-K 6mm ²	Inverter grounding hole	External ground Bar	Inverter side terminals are prefabricated and installed at the factory	-	20m
9	Battery PE	H07V-K 6mm ²	Battery grounding hole	External ground Bar	Battery side terminals are prefabricated and installed at the factory	-	20m
10	iBox PE	H07V-K 6mm ²	iBox Grounding hole	External ground Bar	Cable terminals are prefabricated and installed at the factory	-	20m
11	PV Roof Grounding	NYY-1×6mm ²	PV supporting bracket	External ground Bar	Cable terminals are made and installed on site	-	20 ~ 60m
12	Communication Cable	UTP CAT5e	Inverter Multi-com Connector (COM2)	Battery Inverter COM	Both side terminals are prefabricated and installed at the factory	-	4m
13	Communication Cable	UTP CAT5e	Inverter Multi-com Connector (COM2)	iBox (RS485)	Both side terminals are prefabricated and installed at the factory	-	2m

Note: Indoor wiring connection need to use cable tray.

1.8.2 DC Cable

Type	1×6mm ² DC 1500V
Conductor	Stranded tinned copper (IEC 60228 Class 5) 84/0.285mm (mix0.277mm max0.293mm)
Stranded OD	3.01mm
Inner Insulation	Halogen free crosslinked polyolefin Color: black
Outer Insulation	Halogen free crosslinked polyolefin Color: black
Inner Diameter	4.6±0.15mm
Outer Diameter	6.3±0.15mm
Maximum resistance of conductor at 20°C	≤3.39Ω/km
Insulation resistance at 20°C	≥610 MΩ·Km
Insulation resistance at 90°C	≥0.61 MΩ·Km
Surface resistance of sheath	≥10 Ω
DC Voltage test of insulation	900V, 240h(85°C, 3%NaCl) No break
Tensile strength of insulation	≥10.3Mpa
Rating voltage	IEC/EN: DC1500V AC 1000V
Working temperature	-40~90°C
Max. conductor temperature	120°C
Short circuit temperature	250°C 5S
Bending radius	6×D
Current rating	
Free in air	70A
On surface without opposite contact	67A
On surface with opposite contact	57A
Rating voltage	IEC/EN: DC1500V AC 1000V
Working temperature	-40~90°C
Max. conductor temperature	120°C
Short circuit temperature	250°C 5S
Bending radius	6×D

	CABLE TYPE	UL 11627 10AWG	
CONDUCTOR	Area	1×10AW	
	Material	TXR tinned copper wire	
	Size	105/0.254±0.008mm	
	O.D	3.00 mm	
	20°C max conductor resistance	3.546 Ω/k	
INSULATION	Material	PVC	Insulation: BK
	Normal thickness	0.76 mm	
	O.D.	4.80±0.20mm	
1. Rated voltage: 2000V		1. Tensile Strength: ≥10.3 Mpa	
2. Rated temperature: -15°C-105°C		2. Elongation: ≥100%	
3. Voltage withstand test: 5.0kV		3. Flame test: VW-1	
4. Reference Standards: UL758, UL1581			
5. Maximum conductor Capacity: 30A			

1.8.3 AC Cable

	CABLE TYPE	NYJ-J	
CONDUCTOR	Area	3 G4.0 mm ²	 Insulation: According to requirement
	Material	Bare copper stranded	
	Size	73 / 0.25 ±0.008mm	
	O.D	2.46 mm	
	20°C max conductor resistance	4.95 Ω/km	
INSULATION	Material	FRPVC 40P	
	Normal thickness	1.00 mm	
	O.D.	4.5 ±0.10m	
CABLING	O.D. (ref)	9.7 mm	
	Material	FRPVC	
JACKET	Normal thickness	1.80 mm	
	Minimum thickness	1.43 mm	
	O.D	14.0 ±0.40mm	
1. Rated voltage: 0.6/1kV		1. Tensile Strength: ≥12.5 Mpa	
2. Rated temperature: -15°C~70°C		2. Elongation: ≥125%	
3. Voltage withstand test: AC 4.0kV		3. Flame test: 60332-1	
4. Reference Standards: IEC 60502		4. UV resistance: 300h, UL758	
5. Rated Capacity: 32A			

	CABLE TYPE	NYJ-J	
CONDUCTOR	Area	3 G8.0 mm ²	 Insulation: According to requirement
	Material	Bare copper stranded	
	Size	60 / 0.4 ±0.008mm	
	O.D	3.58 mm	
	20°C max conductor resistance	2.61 Ω/km	
INSULATION	Material	FRPVC 40P	
	Normal thickness	1.20 mm	
	O.D.	6.00 ±0.10m	
CABLING	O.D. (ref)	12.9 mm	
	Material	FRPVC	
JACKET	Normal thickness	2.00 mm	
	O.D	17.0 ±0.40mm	
1. Rated voltage: 0.6/1kV		1. Tensile Strength: ≥10 Mpa	
2. Rated temperature: -15°C~70°C		2. Elongation: ≥100%	
3. Voltage withstand test: AC 4.0kV		3. Flame test: 60332-1	
4. Reference Standards: IEC 60502		4. UV resistance: 300h, UL758	
5. Rated Capacity: 50 A		5.Fixed installation Min bending radius:5×OD	

1.8.4 Earthing Cable

	CABLE TYPE	NYY 1×6QMM	
CONDUCTOR	Area	1 × 6mm ²	
	Material	Bare copper stranded	
	Size	109 / 0.25 ±0.008mm	
	O. D.	3.01 mm	
	20°C max conductor resistance	3.3 Ω/km	
INSULATION	Material	FRPVC 40P	Insulation: YE/GN Jacket: BK
	Normal thickness	1.20 mm	
	Minimum thickness	0.98 mm	
	O.D.	5.40 ±0.2mm	
JACKET	Material	FRPVC	
	Normal thickness	2.00 mm	
	Minimum thickness	1.70 mm	
	O.D.	9.5 ±0.2mm	
1.Rated voltage: 0.6/1kV		1.Tensile Strength:≥10 Mpa	
2.Rated temperature: -15°C~70°C		2.Elongation: ≥100%	
3.Voltage withstand test: AC 4kV		3.Flame test: IEC60332-1	
4. Min. Insulated resistance: 20.0MΩ·km		4.UV resistant: 300h, UL758	
5. Carrying capacity: 40A		5. Fixed installation Min bending radius: 10×OD	
6. Reference Standards: IEC 60502			
7.Maximum conductor temperature: 70°C			
8.Maximum short - circuit temperature: 160°C			

	CABLE TYPE	H07V-K 6.0 mm ²	
CONDUCTOR	Area	6mm ²	
	Material	Bare copper stranded	
	Size	19 / 0.643 ±0.008mm	
	O. D.	3.23 mm	
	20°C max conductor resistance	3.3 Ω/km	
INSULATION	Material	PVC	Insulation: YE/GN Jacket: BK
	Normal thickness	0.80 mm	
	O.D.	4.80 ±0.2mm	
JACKET	Material	//	
	Normal thickness	//	
	Minimum thickness	//	
	O.D.	//	
1.Rated voltage: 450/750V		1.Tensile Strength:≥12.5 Mpa	
2.Rated temperature: 70°C		2.Elongation: ≥125%	
3.Voltage withstand test: 2500V, 5min		3.Flame test: IEC60332-1	
4. Reference Standards: IEC 60502			

2

—

Safety



This manual contains important information about operating the system. Before operating, please read it very carefully. The system should be operated in strict accordance with the instructions in the manual, otherwise it can cause damages or loss to equipment, personnel and property. This manual should be kept carefully for maintenance and reparation.

Setting of Warning Sign for Safety

During instruction, maintenance and repair, follow the instructions below to prevent non-specialist personnel from causing misuse or accident:

- Obvious signs should be placed at front switch and rear-level switch to prevent accidents caused by false switching.
- Warning signs or tapes should be set near operating areas.
- The system must be reinstalled after maintenance or operation.

Measuring Equipment

To ensure the electrical parameters to match requirements, related measuring equipment is required when the system is being connected or tested. Ensure that the connection and use matched specification to prevent electric arcs or shocks.

Moisture Protection

It is very likely that moisture may cause damages to the system. Repair or maintaining activities in wet weather should be avoided or limited.

2.1 Safety notice

iShare-Home Smart Solar System is a new energy generation system that uses PV modules to generate electricity for household loads. Improper use of this system may cause harm to the life and health of the user or third parties as well as damage to the system and other items of value. The following points must therefore be observed in order to comply with the intended use of the system:

- 1 Before performing operations, read through this manual and follow all the precautions to prevent accidents. The DANGER, WARNING, CAUTION, and NOTICE statements in the document do not represent all the safety instructions. They are only supplements to the safety instructions.
- 2 Only certified electricians are allowed to install, connect cables for, commission, maintain, and troubleshoot the system, and they must understand basic safety precautions to avoid hazards.
- 3 The transport and storage conditions must be observed.

PV modules

- 1 Children or unauthorized personnel are not allowed to access the installation area or module storage area.
- 2 Use insulating tools to reduce the risk of electric shock.
- 3 Do not use or install damaged module.
- 4 The installation of the module array must be carried out under the condition that the sun light isolation device is provided, and the installation and maintenance of the module can only be carried out by qualified professionals.
- 5 Do not use a mirror or lens to focus sunlight on module.
- 6 If battery is used in photovoltaic system, the configuration of module shall follow the opinions of battery manufacturer.
- 7 The front glass has the function of protecting the module. The damaged module has the electrical hazard (electric shock and fire). Such module cannot be repaired or repaired, so it should be replaced immediately.
- 8 Do not install module in areas where combustible gases may be present.
- 9 All module systems shall be grounded. If there is any special regulation, please follow international electrical standards or other international standards.
- 10 Do not stand or walk on the package or module; do not drop one module on another.
- 11 Do not install or dispose of module during wet, rainy, snowy or windy periods at the installation site.
- 12 Do not allow the cable plugs to contact each other in wet conditions, which may cause corrosion. Any corroded module shall not be used.

- 13 Do not lift the entire module by grasping the junction box or wire under any circumstances.
- 14 Do not connect the male and female connectors wrongly, check the wiring condition, and all connecting wires shall not be separated from the module.
- 15 Do not let the object directly hit the module or fall on the module directly.
- 16 Do not use sharp tools to scrub the glass of module, which will leave scratches on the module.
- 17 Do not touch the junction box or male and female head with bare hands during installation or when there is light on the module.
- 18 Do not repair the damaged module by yourself.
- 19 Do not split module or move any part of them.

Inverter

- 1 During instruction, maintenance and repair, follow the instructions below to prevent non-specialist personnel from causing misuse or accident:
- 2 Obvious signs should be placed at front switch and rear-level switch to prevent accidents caused by false switching.
- 3 Warning signs or tapes should be set near operating areas.
- 4 The system must be reinstalled after maintenance or operation.
- 5 To ensure the electrical parameters to match requirements, related measuring equipment is required when the system is being connected or tested. Ensure that the connection and use matched specification to prevent electric arcs or shocks.
- 6 It is very likely that moisture may cause damages to the system. Repair or maintaining activities in wet weather should be avoided or limited.
- 7 The battery system is part of the energy storage system which stores life-threatening high voltage even when the DC side is switched off. Touching the battery outlets is strictly prohibited. The inverter can keep a life-threatening voltage even after disconnecting it from the DC and / or AC side. Therefore, for safety reasons, it must be tested with a properly calibrated voltage tester before an installer works on the equipment.

Battery

- 1 SL-BH system installation and maintenance instructions must have high voltage electrical knowledge. Slenergy assumes no liability for injury or property damage due to repairs attempted by unqualified individuals or a failure to properly follow these instructions. These warnings and cautions must be followed when using our product.
- 2 Failure to do so or to follow any of the instructions or warnings in this document can result in electrical shock, serious injury, or death, or can damage SL-BH stackable Li-HV system, potentially rendering it inoperable.

- 8 Please use the accessories designated by Slenergy for construction parts, and do not arbitrarily transform and change the products.
- 9 Please avoid hitting strongly on the profile as aluminum profile is easy to deform and scratch.
- 10 This information is related to the installation of the system. Please consider the characteristics of the stand during the construction of the foundation, components, inverter, and electrical wiring.

iBox

The iBox is used in iShare-home residential PV Systems, which is a new energy generation system that uses PV modules to generate electricity for household loads. Improper use of iBox may cause harm to life and health of personnel as well as damage to the iBox and other items. The following points must therefore be observed to comply with the intended use of the system:

- 1 Before performing operations, read through this manual and follow all the precautions to prevent accidents.
- 2 The DANGER, WARNING, CAUTION, and NOTICE statements in the document do not represent all the safety instructions. They are only supplements to the safety instructions.
- 3 Only certified electricians are allowed to install, connect cables, commission, maintain, and troubleshoot the product, and they must understand basic safety precautions to avoid hazards.
- 4 The transport and storage conditions must be observed.

2.2 Disclaimer

Slenergy shall not be liable for any consequence caused by any of the following events:

- 1 Damage during the transportation by the customer.
- 2 Transport damage (including painting scratch caused by rubbing inside packaging during shipping). A claim should be made directly to shipping or insurance company in this case as soon as the container/package is unloaded and such damage is identified.
- 3 Storage conditions that do not meet the requirements specified in this document.
- 4 Incorrect storage, installation, or use.
- 5 Installation or use by unqualified personnel.
- 6 Fail to follow any/all of the user manual, the installation guide and the maintenance regulations.
- 7 Operation in extreme environments which are not covered in this document.
- 8 Operation beyond specified ranges.
- 9 Unauthorized modifications to the product or software code or removal of the product.
- 10 Device damage due to force majeure (such as earthquake, fire, and storm).
- 11 Warranty expiration without extension of warranty service.
- 12 Installation or use in environments which are not specified in relevant international standards.
- 13 Product modified, design changed or parts replaced without authorization; Changes, repair attempts and erasing of series number or seals by non-company technician.
- 14 System design and installation are not in compliance with standards and regulations.
- 15 Fail to comply with the local safety regulations (VDE for DE, SAA for AU).
- 16 Improper use or misuse of the device; Insufficient ventilation of the device.
- 17 The maintenance procedures relating to the product have not been followed to an acceptable standard.
- 18 Force majeure (violent or stormy weather, lightning, overvoltage, fire etc.)
- 19 Damages caused by any external factors.

2.3 Operator requirements

The installation, electrical connection, commissioning, maintenance, troubleshooting and replacement of the system must be performed by professional technicians. The operator must meet the following requirements:

- 1 Operation personnel should receive professional training or instructing.
- 2 Operation personnel should read through this document and follow all the precautions.
- 3 Operation personnel should be familiar with the safety standards relevant to electrical systems.
- 4 Operation personnel should understand the composition and working principles of the grid-tied PV system and be aware of local regulations.
- 5 Operation personnel must wear proper personal protective equipment (PPE).

2.4 Protecting Labels

Do not scrawl, damage, or block any warning label on the device.

2.5 Operation after Power Failure

The battery system is part of the energy storage system which stores life-threatening high voltage even when the DC side is switched off. Touching the battery outlets is strictly prohibited. The inverter can keep a life-threatening voltage even after disconnecting it from the DC and / or AC side. Therefore, for safety reasons, it must be tested with a properly calibrated voltage tester before an installer works on the equipment.

2.6 Fire Safety

PV Module

Do not install the modules in places where they will be immersed in water or continuously exposed to water wheels or fountains

Please do not apply modules in where exposed inflammable gases are nearby.

Inverter

To reduce the risk of fire, over-current protective devices (OCPD) are required for circuits connected to the Inverter.

Battery

A battery can present a risk of electrical shock, fire, or explosion from vented gases. Observe proper precautions.

If fire, switch off the breaker on DC side and stay away from battery.

2.7 Grounding

2.7.1 PV module grounding

The module needs to be grounded. It has been confirmed that the module meets the safety level II and the grounding method meets the local electrical instructions and regulations.

The grounding connection shall be carried out by qualified electricians.

In design of modules, the anodized corrosion resistant aluminum alloy frame is applied for rigidity support. For safety utilization and to protect modules from lightning and static-electricity damage, the module frame must be grounded. The grounding device must be in full contact with inner side of the aluminum alloy and penetrate surface oxide film of the frame.

Do not drill additional grounding holes on module frame.

The grounding conductor or wire may be copper, copper alloy, or any other material acceptable for application as an electrical conductor per respective National Electrical Codes. The grounding conductor must then make a connection to ground with a suitable ground electrode.

Holes marked with a grounding mark on the frame can only be used for grounding but not for mounting.

Grounding methods below are permissible

A. Grounding by Earthing Clip

The PV module frame and mounting structure rail are made of aluminum alloy coated with oxidized film which is insulated. In order to make PV module frame grounded, a device called earthing clip is used in between PV module frame and mounting structure rail. The earthing clip has sharp strikes on both surfaces which can penetrate the oxidized film on aluminum alloy, conducting PV module frame and mounting structure rail. Please refer to 4.3.5 Installation of PV Modules for detail.

B. The third-party grounding devices

The third-party grounding device can be used for grounding of PV modules but such grounding shall be proved to be reliable.

Grounding device shall be operated in line with stipulations of the manufacturer.

2.7.2 Mounting system grounding

PV module is connected with mounting bracket, and then reliable grounding is completed through download. When connecting the PV module frame and mounting bracket, it is necessary to remove the oxide film on the metal surface to reduce the grounding resistance.

Please refer to the Section 4.3.6 Installation of Grounding Lug.

2.7.3 Inverter grounding

Connect the inverter and ground bar through H07V-K 6mm² wire to achieve the purpose of grounding protection. Please always remember wiring the H07V-K 6mm² wire before wiring other wires.



Do not connect the N-wire as a protective ground wire to the inverter casing. Otherwise, it may cause electric shock.



- Reliable grounding is good for resisting surge voltage shock and improving EMI performance.
- Inverters must be well-grounded.
- For a system with only one inverter, just ground the PE cable.
- For a multi-inverter system, all inverters PE wire need to be connected to the same grounding copper bar to ensure equipotential bonding.

Ground terminal connection steps:

- The external grounding terminal is located in on the lower right side of the inverter.
- Fix the grounding terminal to the H07V-K 6mm² wire with a proper tool and lock the grounding terminal to the grounding hole in the lower right side of the inverter.



2.7.4 Battery grounding

Please refer to 5.7.1 Cable Connection.

2.7.5 iBox grounding

After the mechanical installation is completed, check if the circuit breaker is off. Connect the grounding wire H07V-K 6mm²

3

Transportation and storage



3.1 Storage and transportation of PV modules

3.1.1 Transportation and handling

PV module is made of glasswork and fragile silicon wafer, need to be quite careful during transportation and handling;

- 1 Do not stack module at the project site.
- 2 If the module needs to be covered with rain cloth during long-term turnover to prevent the module from moisture, and do not remove the packaging.
- 3 The packed finished products can be transported by land, sea and air. During the transportation, it is necessary to ensure that the packaging will not roll over.
- 4 Turnover: normal truck transportation can be carried out after stacking up to two layers.
- 5 Do not use the backboard support assembly or the single-back assembly when transporting or installing module. Do not use the rope back assembly.
- 6 It is forbidden to turn around the tricycle. When the project is turned over, only one layer of transportation is allowed.
- 7 Please use a forklift to unload the module from the truck. The forklift can support up to two modules at a time and place the module on the horizontal ground.

3.1.2 Storage

Module should be stored in a dry and ventilated environment to avoid direct sunlight and moisture. If the modules are stored in an uncontrolled environment, the storage time should not exceed three months and additional measures are required to prevent the connectors from getting wet or the module being exposed to sunlight. For example, use a connector cover. Under no circumstances should you stand, climb, walk or jump on module. Partial heavy loads can create microcracks on the battery, which in turn can degrade module reliability.

- 1 Do not support the backboard support assembly when handling or installing module.
- 2 Do not drop or stack items (such as installation tools) on the module.
- 3 It is forbidden to contact the module with sharp objects. In particular, it is necessary to prevent the back plate of the module from being scratched by sharp objects. The scratches directly affect the safety of the module.
- 4 Do not place the module in an environment where there is no reliable support or is not fixed.
- 5 It is forbidden to change the wiring method of the bypass diode.
- 6 Please protect the package from damage. Open the package according to the recommended unpacking procedure. Care must be taken to open the packaging, transportation and storage process.

3.1.3 Unpacking

3.1.3.1 Unpacking security

- 1 When unpacking outdoors, it is forbidden to work under the conditions of rain.
- 2 Wear protective gloves during unpacking to avoid hand injury and fingerprints on the glass side.
- 3 The working floor needs to ensure that the box can be placed horizontally and stably to avoid dumping.
- 4 The unpacking process must be performed by two people at the same time, and the module need to be lifted by both hands.

3.1.3.2 Unpacking

- 1 The package is placed horizontally, dry, and leveled, and the wrapping film, packing tape, upper cover, and carton are removed in turn.
- 2 After the panel is removed and placed between the box and the supporting object, the protection module is not scratched by the support. One person at each short side of the tray is ready to hold the module to prevent the module from falling over after the strap is disassembled. The person removes the strap and the two push the assembly so that the assembly rests on the support.
- 3 If the single glass module needs to be stacked, the pallets are placed on a level surface and the module must be stacked on the pallets; The number of modules is ≤ 5 pcs, and the stacking time is ≤ 2 days; Isolation material must be used between the two modules, the height of the insulation material is greater than the maximum point size of the module protrusion 15mm (junction box), If there is no insulation material, horizontal stacking is not recommended.

3.2 Storage and transportation of inverter

- Do not dispose of the original packing case. It is recommended to store the device in the original packing case when the device is decommissioned.
- The storage temperature and humidity should be in the range of -30°C and +60°C, and less than 90%, respectively.
- If a batch of inverters needs to be stored, the height of each pile should be no more than 6 levels.

3.3 Storage and transportation of Mounting system

- 1 It shall be ensured that no component is damaged during mounting system storage and transportation. Mounting system shall be stored in a dry environment where can avoid corrosion. Besides, don't stack too many boxes together, otherwise, the components at the bottom might be damaged.
- 2 Collision shall be prevented during loading and unloading, to avoid causing mounting system's permanent deformation or mechanical damage.

3.4 Storage and transportation of Battery

3.4.1 Storage requirement

- 1 Install SL- BH Battery at a height that prevents damage from flooding.
- 2 Operating or storing SL-BH Battery in temperatures outside its specified range might cause damage to SL-BH Battery.
- 3 Do not expose the SL-BH Battery to ambient temperatures above 55°C (131°F) or below -20°C (-4°F).
- 4 Ensure that no water sources are above or near Battery, including downspouts, sprinklers, or faucets.
- 5 Do not sit or put heavy things on product.
- 6 Do not drop, deform, impact, cut or spearing with a sharp object.
- 7 Do not place close to open flame or flammable material.
- 8 Do not place at a children's and pet's reach.

3.4.2 Shipping requirements

- 1 The product has UN38.3 transportation certification;
- 2 Product packaging meets sea/automobile transportation requirements;
- 3 During transit, it should be strictly installed when stacking plates when leaving the factory;
- 4 Do not open the bulk cargo for transportation, do not open the package for transportation;
- 5 The operation of the forklift during transit requires the operation of licensed professionals to avoid damage to the product or packaging;

- 6 No violent transportation (such as smashing, crushing, pedaling, etc.);
- 7 The consignee shall take photos to save the photos of the goods at the time of receipt;
- 8 Product packaging meets the requirements of sea/automobile transportation;
- 9 During transit, it should be strictly installed when stacking plates when leaving the factory;
- 10 Bulk cargo shall not be disassembled for transportation, and shall not be unpacked for transportation;
- 11 Forklift operation during transit requires licensed professionals to avoid damage to the product or packaging;
- 12 No violent transportation (such as smashing, crushing, pedaling, etc.);
- 13 The consignee shall take photos to save the photos of the goods at the time of receipt.

3.5 Transportation and storage of iBox

if the iBox does not need to be installed for the time being, the following should be noted when storing.

3.5.1 Storage environment

The iBox shall be stored in a cool, dry, water-free steam-free or corrosive gas-free, dust-free environment with ambient temperature not exceeding -25°C~60°C.

Design protection grade of iBox is IP54, but before installing wiring, the inlet and outlet holes are not locked and may be in open state. At this point, if exposed to rain or water vapor, ingress of water vapor or corrosive gas into the iBox may occur, and then affect the electrical performance of the iBox and safe use.

Stacking Restrictions

The iBox should be stacked horizontally, vertical stacking is prohibited.

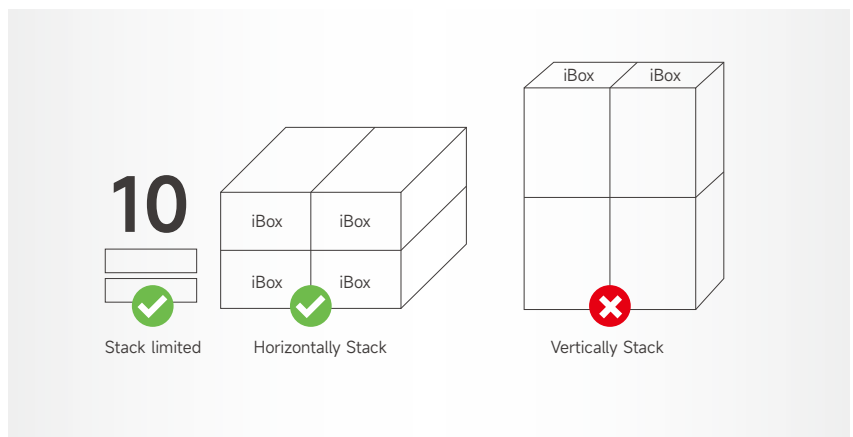

When the iBoxes are stacked horizontally, should be no more than 10 layers.

Using after long-term storage

If the iBox is stored for more than one year, the user should have it checked and tested by a professional person, or contact the manufacture.





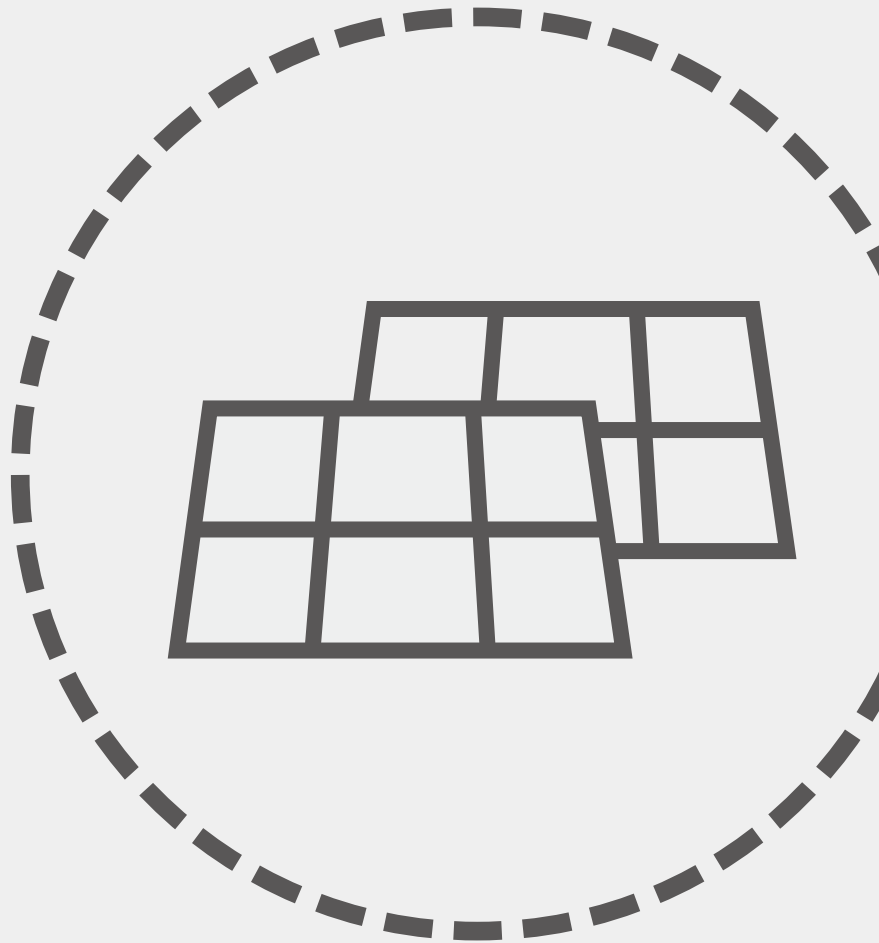





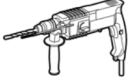



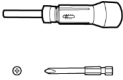

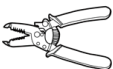
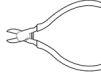





4

Equipment installation



4.1 Checking Before Installation

4.1.1 Installation tools

Type	Tools			
				
	Hammer drill: Drill bit: $\Phi 10$ mm	Socket wrench set	grinding machine	Multimeter DC voltage measurement range $\geq 1100V$ DC
				
	Torque screwdriver Phillips head: M5	Removal wrench Model: H4TW0001; manufacturer: Amphenol	Crimping tool Model: H4TC0003/ H4TC0002 manufacturer: Amphenol	Wire stripper
Installation Tools				
	Diagonal pliers	Utility knife	Cable cutter	OT terminal crimping tool
				
	Hammer	Measuring tape	Bubble or digital level	Vacuum cleaner
				
	Heat shrink tubing	Heat gun	Cable tie	Marker
PPE				
	Safety gloves	Safety goggles	Anti-dust respirator	Safety shoes

4.1.2 Check before the PV module installation

Before installing module, you should contact the relevant department to obtain information about the installation site and construction permit, and also comply with the requirements of the authorized party for installation and inspection.

- 1 When installing the module, make sure that the modules are installed on a fire-resistant roof.
- 2 If the terminal of the PV module is wet, no work can be done to avoid electric shock. It is recommended to install it immediately after unpacking.
- 3 Do not stand on the glass when working, so as to avoid damage caused by broken glass or risk of electric shock.
- 4 Don't work alone (Always keep working with a team of 2 or more people).
- 5 When fastening the PV assembly to the bracket by clamps or screws, do not damage the back panel of the PV assembly.
- 6 Take precautions during installation to prevent the module from being squeezed or impacted by external forces.

4.1.2.1 Installation condition

- **Working environment**

The recommended installation ambient temperature is between -40°C and 85°C .

Do not install the module where they may be immersed in water.

- **Installation site**

Note: The mechanical load of the module (including the pressure of wind and snow) is based on the installation method and installation location. The mechanical load must be calculated by a professional installer based on the design requirements of the system.

In general, solar modules should be installed at locations where they receive the lightest throughout the year. In the northern hemisphere, the modules are best placed south, while in the southern hemisphere, the module are best placed north. If the tilt angle of the module deviates from the positive south (or north) direction by 30 degrees, approximately 10% to 15% of the power output will be lost; If the tilt angle of the module is 60 degrees away from the true south (or north) direction, approximately 20% to 30% of the power output will be lost. When choosing a location, avoid trees, buildings, or other obstacles that create shadows on the module. Although the manufacturer has installed appropriate bypass diodes to minimize this loss, the shadows still cause a reduction in output power.

When a photovoltaic power generation system uses a battery, the battery must be installed correctly, which can protect the operation of the system and ensure the safe use of the user; Please follow the battery manufacturer's instructions for installation instructions, operation and maintenance; In general, batteries should be kept away from the main traffic routes of people and animals; While ensuring the normal operation of the battery, avoid direct sunlight, rain and snow erosion, and maintain good ventilation; Most batteries generate hydrogen when they are charged, which is prone to explosions. Do not spot fire or create sparks around the battery. If the battery is installed outdoors, it must be placed in a specially designed location with good insulation and ventilation.

Do not install module near open flames or flammable materials.

Do not install the module where they are soaked in water or where they are continuously exposed to waterwheels or fountains.

4.1.3 Checking before iBox Installation

The following cautions should be noticed before installing the iBox.



Electric shock! Installation and operation by on-professional personnel is prohibited.
Make sure the power is off during installation and maintenance/operation.

Do not operate AC IN or AC OUT/Backup IN or Backup OUT plug when load is on.

If the AC IN or AC OUT/Backup IN or Backup OUT plug needs to be disconnected, make sure both are disconnected, do not leave only one of the plugs connected to the box. After disconnecting both the plugs, wait for no less than 2 minutes to make sure no electricity is left in the iBox.







Install the iBox, the hybrid inverter and battery packs in the same room, and the distance should be less than 20m between the iBox and the original distribution box, the distance between iBox and the hybrid inverter should be less than 2m.

Packing List of iBox package

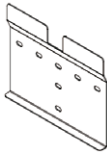
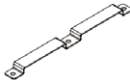
No.	Item	Specification	Qt'y	Unit	Remarks
1	iBox	SL-BH5KL\SL-BH10KL	1	Pcs	
		Mounting plate-A	1pcs		
		Mounting plate-B	1pcs		
2	Installation	Mounting plate-C	1pcs	1	Set
	Accessories	Screws M6×10	5pcs		
		Screws ST6.3×60 T30	4pcs		
		Expansion tubeφ6×60 T30	4pcs		
3	Inspection report	\	1	Pcs	
4	Feedback Form	\	1	Pcs	
	Installation	\	1	Pcs	
5	Dimensions				
	Quality	\	1	Pcs	
6	Certificate				
	PV Connector	PV Connector Positive Electrode Housing 4pcs	1	Set	
7	Accessories	PV Connector Positive Electrode Terminal 4pcs			
	PV Connector	PV Connector Negative Electrode Housing 4pcs	1	Set	
8	Accessories	PV Connector Negative Electrode Terminal 4pcs			

iBox Mounting Accessories

No.	Item	Picture	Quantity
1	Mounting Plate-A		1pcs
2	Mounting Plate-B		1pcs
3	Mounting Plate-C		1pcs
4	ST6.3 Screws		4pcs
5	Plastic expansion tube		4pcs
6	Screws		5pcs

4.1.4 Checking before Mounting system Installation

Slenergy tile hook/hanger bolt system is a roof photovoltaic mounting system applied to tile roofs. The hooks and bolts are designed based on various types tile roofs. In that case, each roof has its corresponding and fitting hook for installation, which greatly improves the firmness of the connection between mounting system and roof structure. Multiple high-quality components and different types of rails can be used for different types tile roof in different countries and regions, while improving the stability of the overall supports. The whole system has fewer mounting accessories, which saves the users' installation time and cost. It is an efficient solution for large-scale tile roof projects.

Main Components

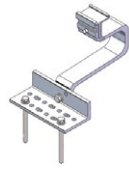

Hook

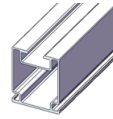

Rail

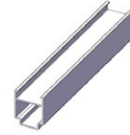

Rail Splice

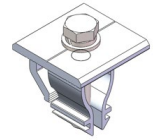

Common End Clamp



Common Mid Clamp

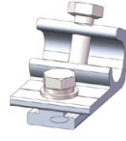

Grounding Lug

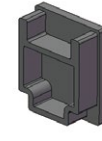

Rail Cap



Hanger Bolts

4.1.5 Checking before inverter Installation

4.1.5.1 Appearance

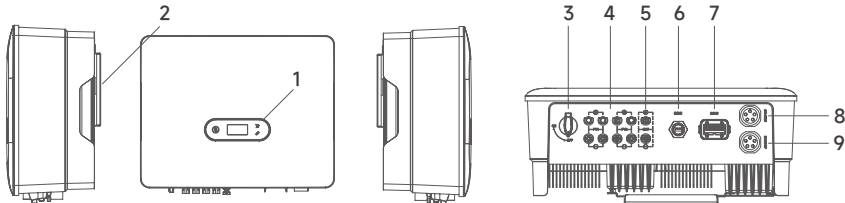

Figure 4.1.5.1-1 Inverter Appearance

Technical Parameter

Item	Terminal	Note
1	Display and LED panel	Display the operation information and working states of the inverter.
2	Hanger	Used to hang the inverter on the wall-mounting bracket.
3	DC switch	Used to safely disconnect the DC circuit
4	DC input terminal	PV connector
5	Battery input terminal	Battery connector
6	COM1 por	WiFi/LAN/4G module connector
7	COM2 por	Multi-function Connector (Meter/BMS/RS485/DRED)
8	On-grid output terminal	Used for On-grid output cable connection
9	Back-up output terminal	Used for Back-up output cable connection

The device is thoroughly tested and strictly inspected before delivery. Nonetheless, damage may still occur during shipping. For this reason, please conduct a thorough inspection after receiving the device. Contact Slenergy or the transport company in case of any damage or incompleteness, and provide photos to facilitate services.

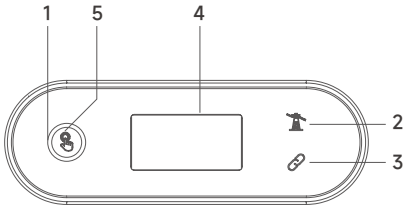

Figure 4.1.5.2-1 Inverter display interface

4.1.5.2 Indicator

Item	Indicator	Status	Description	
1	Power and Alarm Indicator	Off	No power	
		Blue	Quick flashings	Inverter entered self-test status.
			Slow flashing	Inverter entered waiting status.
			Breathe flashing	Inverter works normal.
		Orange	Breathe flashing	Low battery warning, the battery power is about to reach the SOC protection value.
Red	Always on	An alarm or fault is detected, view the fault info on the display.		
2	Grid Indicator	Off	Grid lost.	
		Slow flashing	Inverter detected grid but not running in on-grid mode.	
		Always on	Inverter works in on-grid mode.	
3	Communication Indicator	Green	Always on	The inverter communication is running normally.
		Green	Flashing	The inverter communicates with EMS or Master inverter through RS485 or CAN.
		Orange	Always on	The inverter isn't communicating with Slenergy smart meter.
		Red	Always on	The inverter isn't communicating with the BMS.
4	Display	Display off to save power, press the button to wake up the display.		
5	Button	Switch display information and set parameters by short press or long press.		

4.1.5.3 Packing List

The package of the inverter includes the following accessories. Please check whether the accessories in the packing box are complete when receiving the goods.

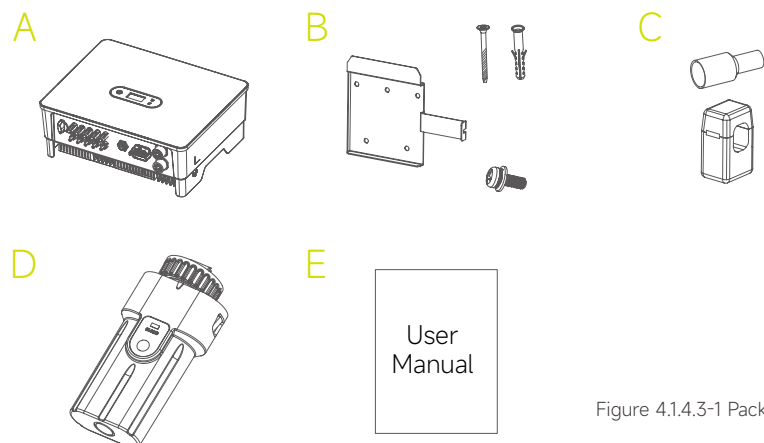

Figure 4.1.4.3-1 Packing list

A	Inverter (1pcs)
B	Wall-mounting bracket (1pcs), Expansion plug set (5pcs), M5 screws (1pcs)
C	CTs
D	Monitoring device (1pcs)
E	User Manual

4.1.6 Checking before battery installation

4.1.6.1 Appearance Introduction

Control Module

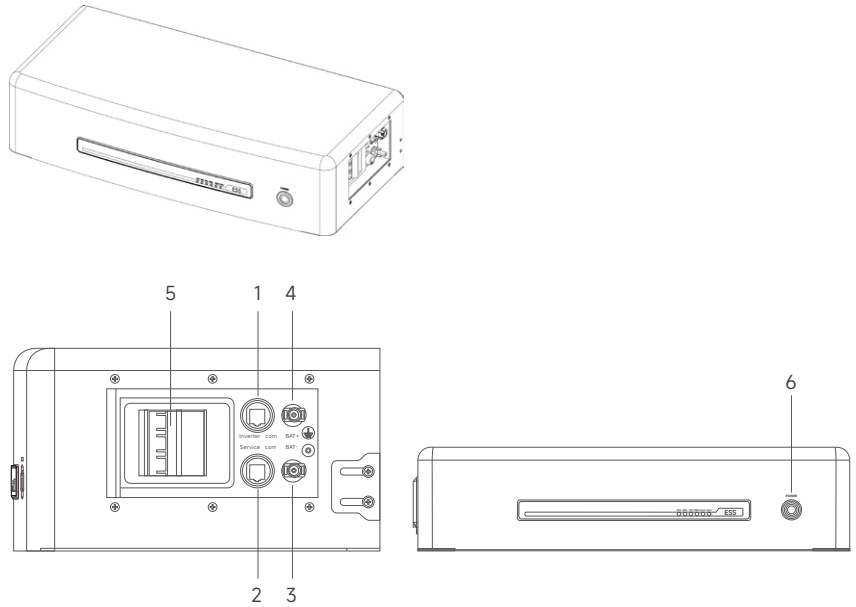

Item	Terminal	Note
1	Inverter COM	Connect to the inverter communication port
2	Service COM	Specified Debug Interface
3	Battery output -	/
4	Battery output +	/
5	Battery MCB	Control battery output
6	Power button	Turn the battery on and off

Battery Module

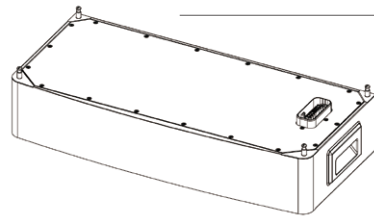



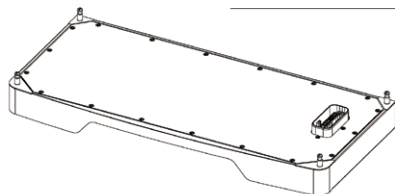



Base



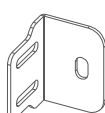

4.1.6.2 Packing List

The package includes 1PCS control battery module, 1-9PCS slave battery modules, and 1PCS battery base and other installation accessories. Please check if the battery modules and accessories are complete in the package when receiving the goods, See the following figure for your reference.



Control module packing list

			
Control Module×1PCS	M5-10 installation screw×4PCS	8-60Expansion screw×2PCS	Fixed bracket×2PCS
			
Grounding Screw×1PCS	User Manual×1PCS	Quality Certificate ×1PCS	

Battery module packing list

			
Battery Module×1PCS	Alignment pin×4PCS	Quality Certificate ×1PCS	

Battery module packing list

			
Base×1PCS	Alignment pin×4PCS	Quality Certificate ×1PCS	

4.2 Installation Mounting system and PV module installation

4.2.1 Mounting angle

The tilt angle of a solar module refers to the angle between the surface of the module and the ground plane (see Figure 1 below). The power output is greatest when the module is facing the sun.

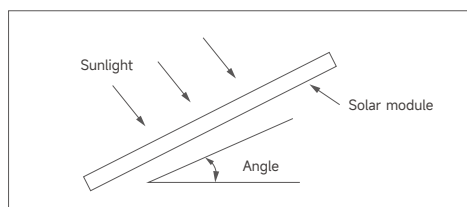

Figure 4.2.1-1 Mounting angle

4.2.2 Installation method introduction

4.2.2.1 Fixture installation

If connected to a stand-alone PV system, the installation angle of the module should be maximized in terms of season and lighting conditions. In general, if the output of the module can be satisfied with the lowest light intensity in a year, the module output of the selected angle can meet the needs of the whole year; For systems connected to the grid, the installation angle of the module should be based on the basic principle of maximizing output throughout the year.



Installation of side fixture(≥50mm)



Installation of middle fixture(≥40mm)

- When the briquetting method is selected, ensure that there are at least 4 briquettes on each module. Install two on each long side (longitudinal) or each short side (lateral) of the assembly. How many pressure blocks are used in the fixture depends on the local wind and snow pressure intensity. If the pressure exceeds the expected estimate, additional clamps or brackets are required to ensure that the assembly can withstand this pressure.
- After testing its module with different fixtures from multiple manufacturers, it is recommended to use clamps with EPDM or similar insulating gaskets that can at least secure M8 bolts.
- The fixture must clamp the frame of the assembly more than 7mm but not more than 10mm, and the minimum spacing between the two modules is 10mm.
- The module fixture cannot be in contact with the glass on the front side and must not deform the frame. Be sure to avoid the shading effect of the module fixture.
- The frame of the module cannot be adjusted under any circumstances; the drain hole cannot be blocked under any circumstances during installation or use.
- The applied torque shall be determined according to the mechanical design criteria of the bolts used by the customer, for example: M8 ---- 16-20N. (140-180lbf.in)
- If the customer needs other sizes of compacts, Slenergy is required for full evaluation.

4.2.2.2 Mounting hole mounting

- Use the bolts to secure the assembly to the bracket through the mounting holes on the back frame of the assembly. The mounting details are shown below.
- Each module has a 4-φ9*14mm mounting hole on the long bezel, which allows the assembly to be securely attached to the support structure.
- To maximize installation life, Slenergy recommends the use of corrosion-resistant (stainless steel) fasteners
- As shown, use M8 bolts, flat washers, spring washers and nuts to secure the assembly at each fixed position and tighten to 16 to 20 N.m (140-180 lbf.in) of torque.
- All parts in contact with the frame shall be flat stainless-steel washers with a minimum thickness of 1.8 mm and an outer diameter of 20-24 mm (0.79-0.94 inches).

4.2.2.3 Module installation method

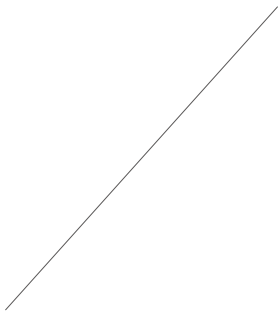
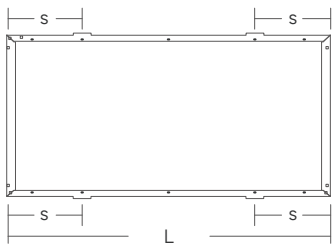
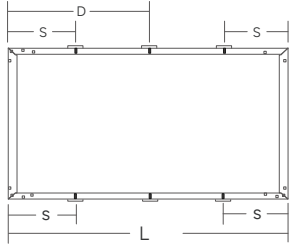
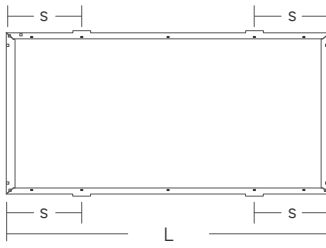
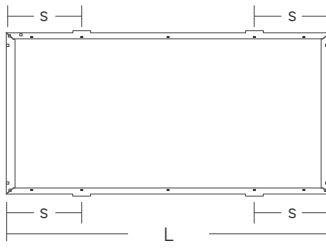
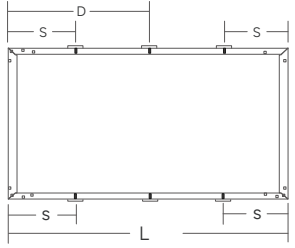
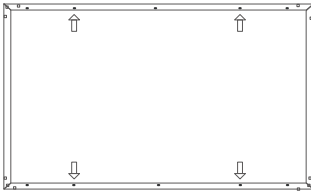
Load pressure	+2400Pa/-2400Pa	+5400Pa/-2400Pa
Use a fixture to mount the long bezel(60 half pieces)		<input type="checkbox"/> Fixture allows installation range $(1/4 L-50) < S < (1/4 L+50)$  Module length L
		<input type="checkbox"/> Fixture allows installation range $(1/5 L-50) < S < (1/5 L+50)$ $(1/2 L-50) < D < (1/2 L+50)$  Module length L
Use a fixture to mount the long bezel(72 half pieces)		<input type="checkbox"/> Fixture allows installation range $(1/4 L-50) < S < (1/4 L+50)$  Module length L
		<input type="checkbox"/> Fixture allows installation range $(1/5 L-50) < S < (1/5 L+50)$ $(1/2 L-50) < D < (1/2 L+50)$  Module length L
Use a fixture to mount the long bezel		<input type="radio"/> Mounting holes Use 4 mounting holes
		<input type="radio"/> Mounting holes Use 8 mounting holes

Note:
 All installation methods described here are for reference only. Slenergy is not responsible for providing related installation module, design and installation of module systems. Machine load and safety must be done by a professional system installer or an experienced person.

Before installation, you need to confirm the following important items:

- (a) Before installation, check for bugs or other debris, if any, and erase.
- (b) Check that the serial number of the module is correct.

4.3 Installation of mounting structure

4.3.1 Installation Precaution

Notes for the installation dimensions

The specific dimensions of all installations involved are subject to the construction drawings. This installation instruction is only for the description of the product installation method.

Notes for Stainless Steel Fasteners

Because of the good ductility for stainless steel, the fasteners have big difference with carbon steel one in nature. If use in improper way, it will result in bolt and nut being "locked", which commonly known as "seizure". Prevention from lock basically has the following ways:

- **Reduce the Friction Coefficient**

- (1) Ensure that the bolt thread surface is clean and tidy (No dust, grit, etc.);
- (2) It is recommended to use yellow wax or lubricant during installation (such as lubricating grease, 40# engine oil, which are prepared by users).

- **Correct Operation Method**

- (1) The bolt must be perpendicular to the axis of the thread, and not inclined (Do not tighten Obliquely);
- (2) In the process of tightening, the strength needs to be balanced, tightening torque shall not exceed the prescribed safety torque value;
- (3) Choose torque wrench or socket wrench as far as possible, avoid using adjustable wrench or electric wrench. Lower the rotating speed while have to use electric wrenches;
- (4) Avoid using electric wrenches etc. under high temperature conditions, do not rotate fast when using, to avoid rapid rise in temperature and cause "seizure".

4.3.2 Installation of Tile Hook/Hanger Bolt

Self-tapping screws of tile hook need to be fixed to the roof purlins. Please mark the positions of tile hook according to shop drawing and make sure all tile hooks are installed on the same horizontal line. Then install the tile hooks accordingly and fasten them to the roof purlins by self-tapping screws.

Shown as bellow:

- Mark the positions of tile hook on the roof and make sure they are on the same horizontal line.

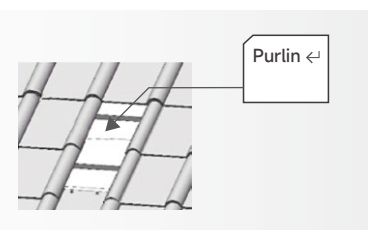
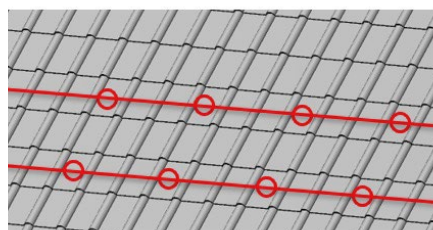

For Spain and Italy country, two types of fixtures of mounting structure are provided. The installation guide is listed here for both. Please refer to the corresponding guide for the type you are using.

4.3.2.1 Installation of hanger bolt

Calculate the hanger bolt span in Slenergy calculation tool based on snow zone, wind zone, altitude and other parameters. The actual installed hanger bolt span has to be not more than the calculated value in Slenergy calculation tool, otherwise the mounting structure might have risk of failure when it comes to extreme condition.

The hanger bolts need to be fixed on the rafter underneath tile, plan the location where hanger bolt kit will be installed on rooftop first, then use alignment line to ensure the subsequent hanger bolt are installed on the same line, make a mark on the wave crest of tile, and then use electrical drill to drill a $\Phi 10$ hole at the marked position. Finally, pass the hanger bolt through the predrilled hole and fix it on the rafter. the installation step is also shown in the figure below:

- The installation diagram of hanger bolt, L feet and rail clamp:

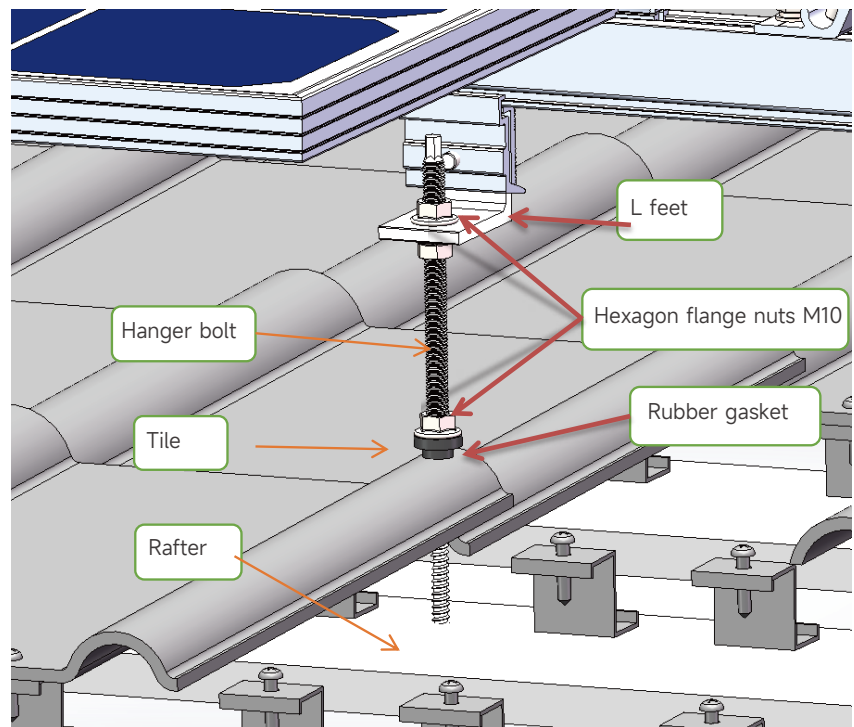

- The hanger bolt kits are installed on tile as shown figure below:

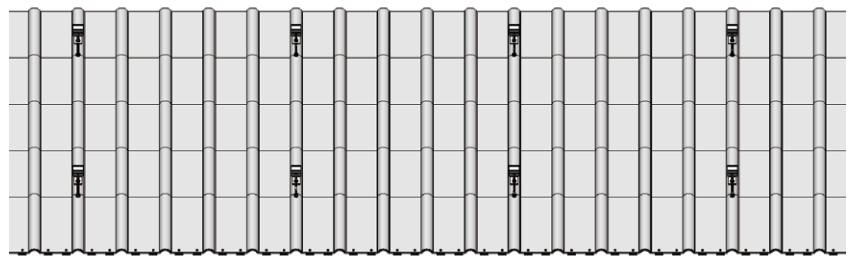

4.3.2.2 Installation of tile hook

Calculate the hook span in Slenergy calculation tool based on snow zone, wind zone, altitude and other parameters. The actual installed hook span has to be not more than the calculated value in Slenergy calculation tool, otherwise the mounting structure might have risk of failure when it comes to extreme condition.

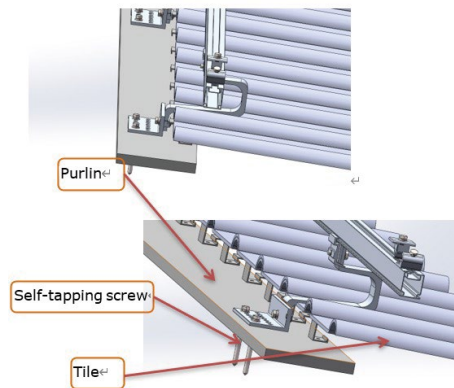

- Install all hooks to the tile roof.



4.3.3 Installation of Rail

Fix rails to tile hooks after adjusting the length and height and tighten them by bolts.

After fixing the hook, adjust the height of the rail, loosen the bolt on the upper end of the hook to separate the key A and key B for a certain distance, first align the protrusion of key B with the groove of the rail, and then rotate the rail until the concave on the other side is aligned with the protrusion of key A and locked. The length of rail shall be selected according to the corresponding drawings.

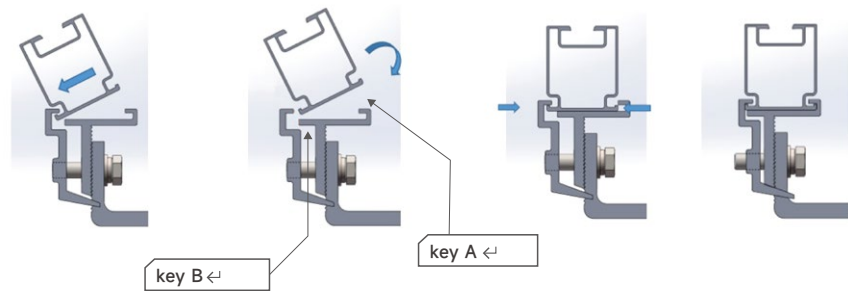

- Connect and fix the remaining rails to the hook according to the previous step.



Figure 4.3.3-2 Hook type

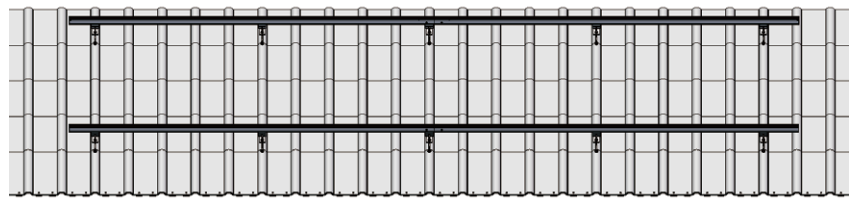
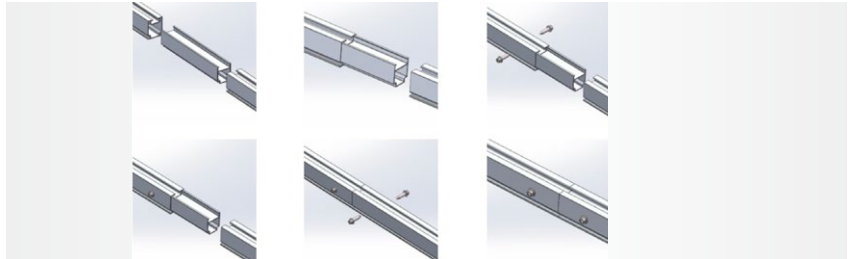

Figure 4.3.3.-3 Hanger bolt type

4.3.4 Installation of Rail Splice

Rails should be connected by rail splice if needed, as shown below:

Slide half of the rail splice into the first rail, adjust the fixed position, and tighten the bolts. Then slide the second rail into the rail splice, tighten them by bolts when leveled.



- Completed installation is as the picture shown below

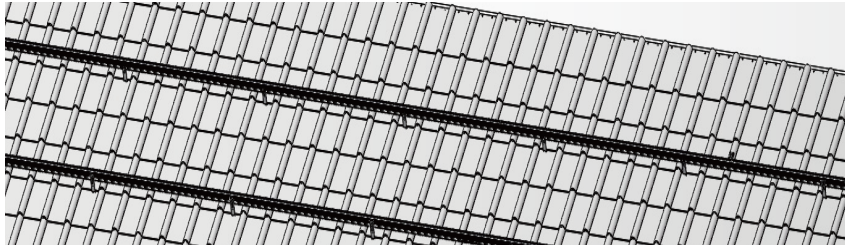

Figure 4.3.4-2 Hook type completed installation

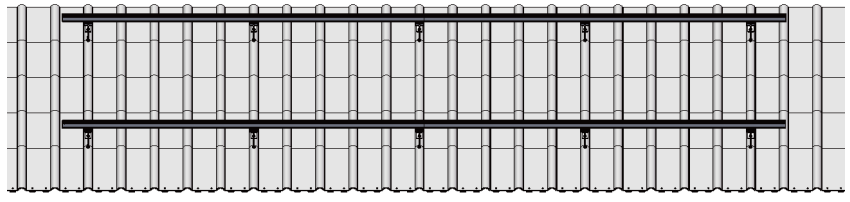

Figure 4.3.4-3 hanger bolt type completed installation

4.3.5 Installation of PV Modules

According to the installation dimension of the drawing, place the PV modules on the rail, and press and fix it with the common end/mid clamp. Note that when the clamps are installed, as shown in the figure below, the mounting surface of the common mid clamp is different, and it needs to be rotated by 90 degrees.

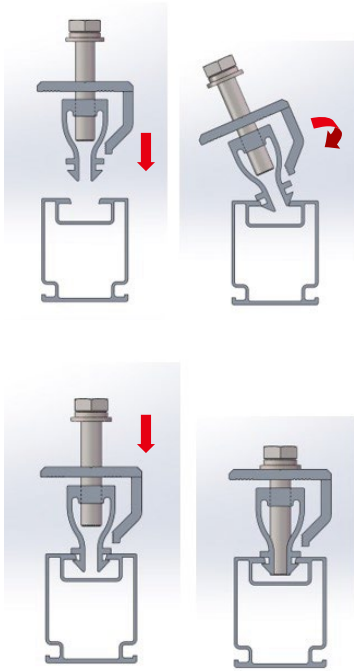
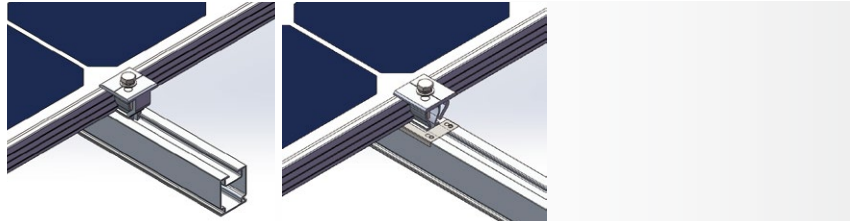
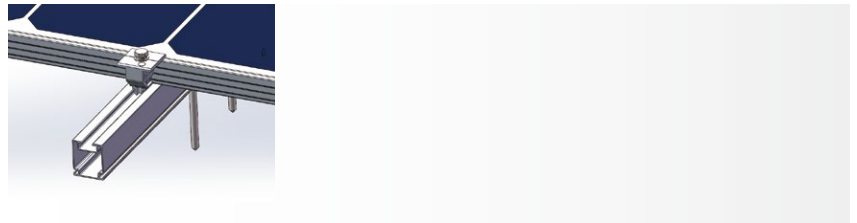

Figure 4.3.5-1



Place the PV module on the rail and adjust the position according to the drawing.

Then fix the end clamp into the rail channel, and tighten the bolts.



After fixing the end clamp of first PV module, please put the second PV module on the rail at proper position.

Connecting firmly the first PV module and the second one with mid clamp and fasten the bolts. If there are earthing clips needed, place them between the PV modules and rails while installing the mid clamps. Adjusting the position to ensure the sharp spikes on earthing clips are pressed by both PV modules. Then tighten the mid clamps by bolts.

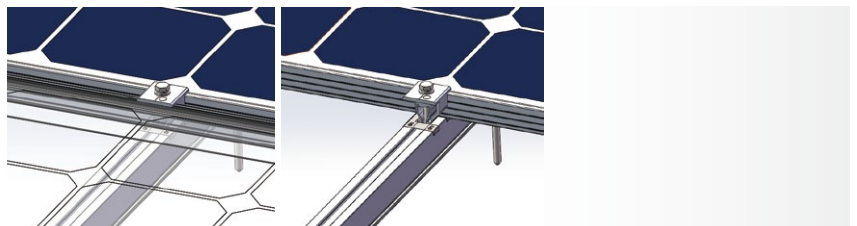

Repeat the steps above. When it comes to the last PV module, fix it with the end clamp and tighten with bolts.

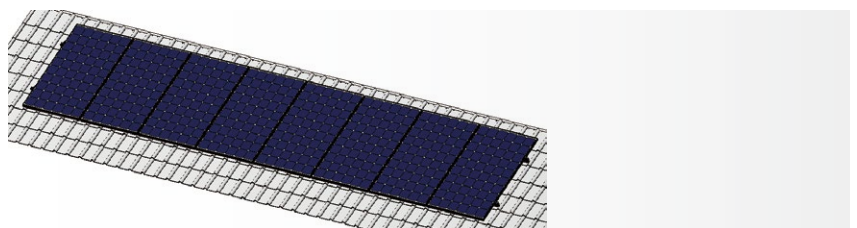

4.3.6 Installation of Grounding Lug

Install grounding lug at the end of the rail as the picture shown below and fix it with bolts.

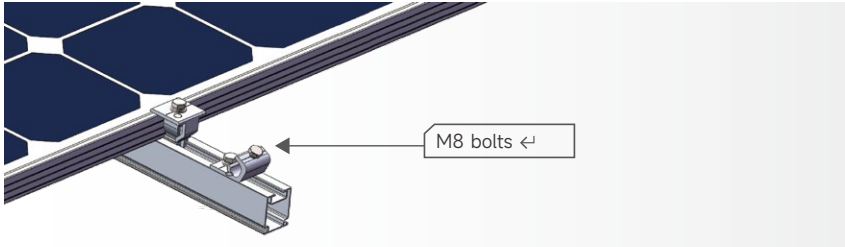

At the edge of the layout, connect each grounding lug with NYY 1*6mm² ground cable , use knife to cut a small notch at the position where grounding cable sit on the grounding lug, and then fix the ground cable with M8 bolts, and conduct the end of the ground cable to the grounding point.

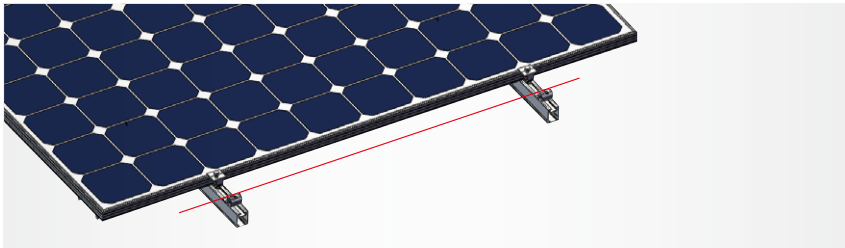

4.3.7 Installation of Rail Cap

Align the rail cap with the end of the rail and buckle it in.

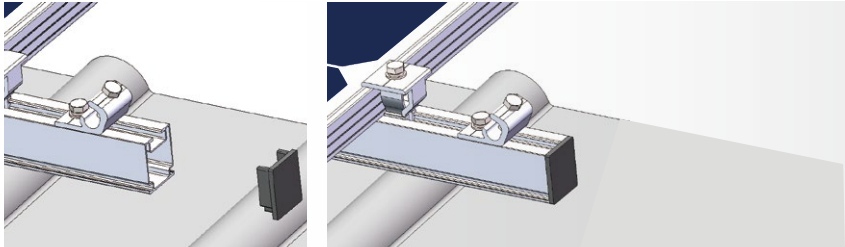

4.3.8 Installation Diagram

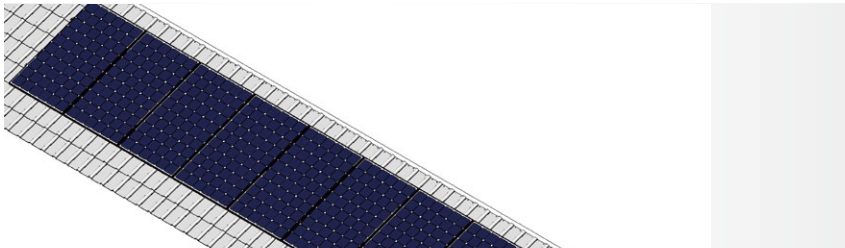

Figure 4.3.8-1 Axonometric drawing

Assembling the PV Connector

Make sure that the connectors are securely connected and properly connected. The connectors must not be subjected to external pressure. The connectors can only be used for circuit connection functions and should not be used to turn the circuit on and off. Connections should be kept dry and clean to prevent rain and moisture. Avoid direct sunlight and water soaking of the connector.

Insert the positive and negative cables into the corresponding positive and negative connectors, pull back the DC cable to ensure that the terminal is tightly attached in the connector.

Use an open-end wrench to screw the nut to the end to ensure that the terminal is well sealed.

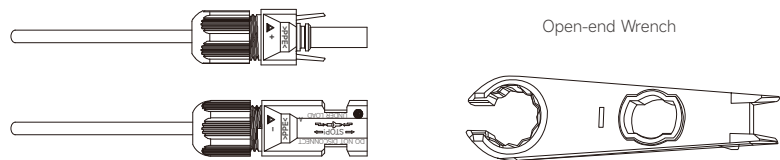

- The connector does not have any waterproof function before docking. When installing the module, it is necessary to dock the connector as soon as possible or take waterproof measures to prevent the connector from being exposed to moisture and dust.
- When connecting in series, the solar modules with the same gear current must be selected for connection. The voltage of the module connected in series cannot be higher than the maximum voltage allowed by the system. The number of modules per string depends on the system design, inverter type and environmental conditions.
- The maximum rated fuse current value of each string of module is identified in the product label and specification sheet. The rated fuse current corresponds to the maximum reverse current value of the module. Based on the maximum fuse current and local electrical performance installation requirements, match the appropriate fuse to protect the series-parallel module in the circuit.

4.4 Inverter installation

4.4.1 Determining the Installation Position

The Slenergy SL-D3-8KTL series inverters are designed with IP65 protection enclosure for in-door and outdoor installations. When selecting an inverter installation location, the following factors should be considered:

- The wall on which the inverters mounted must be able to withstand the weight of the inverter.
- The inverter needs to be installed in a well-ventilated environment.
- Do not expose the inverter directly to strong sunlight to prevent excessive temperature operation. The inverter should be installed in a place with shelter to prevent direct exposure to sunlight and rain.
- Install the inverter at eye level for easy inspection of screen data and further maintenance.
- The ambient temperature of the inverter installation location should be between -30°C and 60°C .
- The surface temperature of the inverter may reach up to 75°C . To avoid risk of burns, do not touch the inverter while it's operating and inverter must be installed out of reaching of children.

4.4.1.1 Installation location

Select an optimal mounting location for safe operation, long service life and expected performance.

- The inverter with protection rating IP65 can be installed both indoors and outdoors.
- Install the inverter at a place convenient for electrical connection, operation, and maintenance.

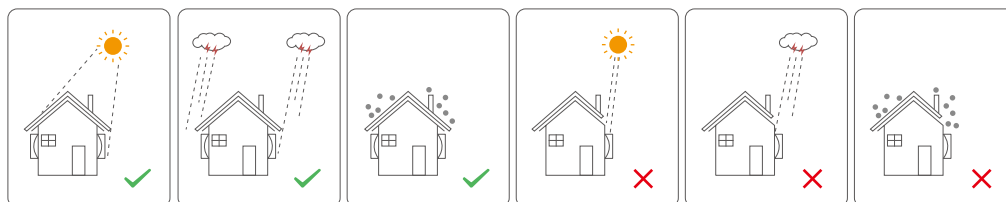

Figure 4-1 Recommended installation location

WARNING

Install the inverter in the same room of the original distribution box of the user, and the distance should be less than 10m between the inverter and the original distribution box.

Do not put flammable and explosive articles around the inverter.

Installation Angle Requirements

Install the inverter vertically. Never install the inverter horizontally, or at forward/backward tilted, or upside down.

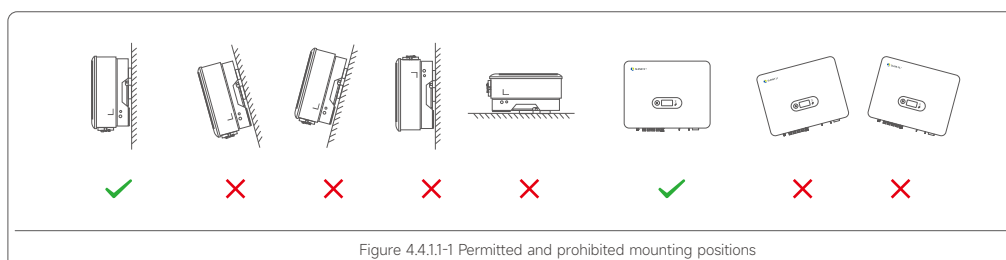

Figure 4.4.1.1-1 Permitted and prohibited mounting positions

4.4.2 Mounting the Inverter

4.4.2.1 Wall Bracket Installation

Dimensions of wall bracket (mm)

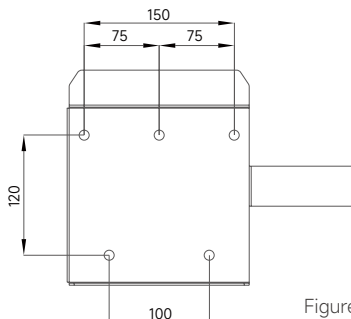

Figure 4.4.2.1-1 Dimensions of wall bracket

- Use the wall bracket as the template to mark the position of 5 holes on the wall.

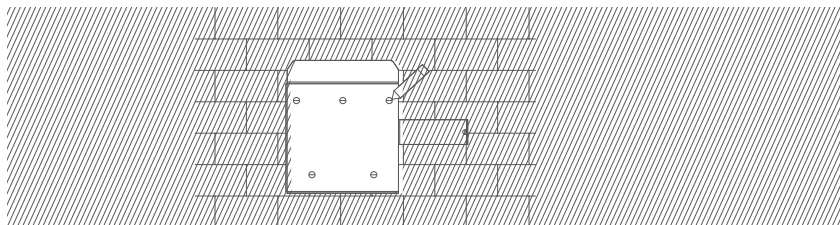

Figure 4.4.2.1-2 Marking hole position using installation bracket

- Use an electrical driller with 10mm diameter bit to drill 5 holes in the wall with 80mm depth.



Before drilling, make sure to avoid any buried water tube and electric wires in the wall.

- Insert the expansion tubes into the holes and tighten them, then fix the bracket onto the wall with expansion screws by using a cross screwdriver.

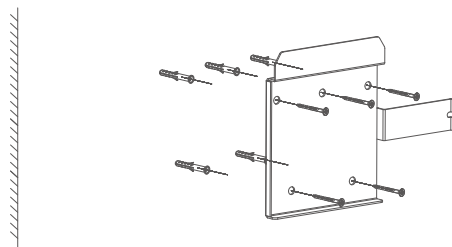

Figure 4.4.2.1-3 Fixing the wall bracket

4.4.2.2 Mounting the Inverter

Lift the inverter, hang the back rail on the fixed wall bracket carefully. Secure the inverter with M5 screws.

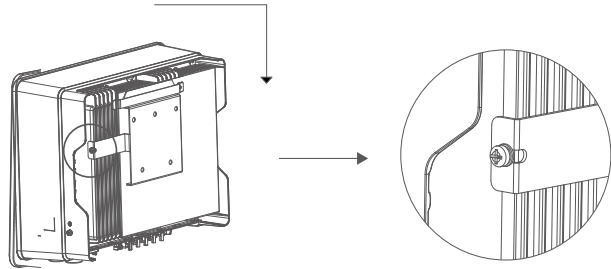

Figure 4.4.2.2-1 Mounting the inverter

4.4.3 External Ground Connection

Connect the inverter and ground bar through PE wire to achieve the purpose of grounding protection. Please always remember wiring the PE wire before wiring other wires.



Reliable grounding is good for resisting surge voltage shock and improving EMI performance. Inverters must be well-grounded.

For a system with only one inverter, just ground the PE cable. For a multi-inverter system, all inverters PE wire need to be connected to the same grounding copper bar to ensure equipotential bonding.

Ground terminal connection steps:

- The external grounding terminal is located in on the lower right side of the inverter.
- Fix the grounding terminal to the PE wire with a proper tool and lock the grounding terminal to the grounding hole in the lower right side of the inverter.

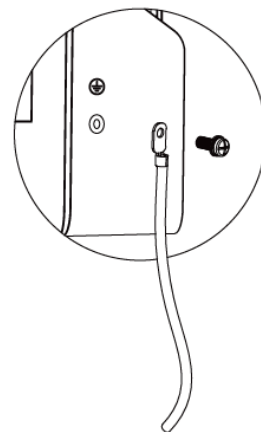

Figure 4.4.3-1 Grounding terminal connection

4.5 Battery installation

4.5.1 Location Requirements

- The area is completely water proof. The floor is flat and level.
- There are no flammable or explosive materials.
- The ambient temperature is within the range from -20 to 55 degree.
- The temperature and humidity are maintained at a constant level. There is minimal dust and dirt in the area.
- The distance from heat source is more than 2 meters.
- Keep the distance of the whole battery system from the air outlet more than 0.5m. Do not cover or wrap the battery cabinet please!
- Keep the battery out of kids and pets reach please. There should be no direct sunlight at the installation location.
- There are no mandatory ventilation requirements for battery module, but please avoid installation in confined space (Installation to the wall should between 20-120mm).
- The aeration shall avoid of high salinity.
- Make sure the load capacity of the floor not less than 500KG.

4.5.2 Mounting Battery

4.5.2.1 Install the Base

Install base guide pins.

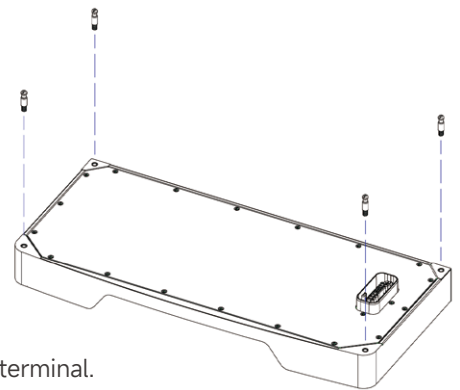

Peel off the protective film on the terminal.

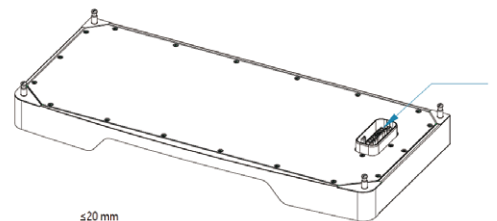

Install the battery system as close to the wall as possible to make sure the gap is less than 20mm.

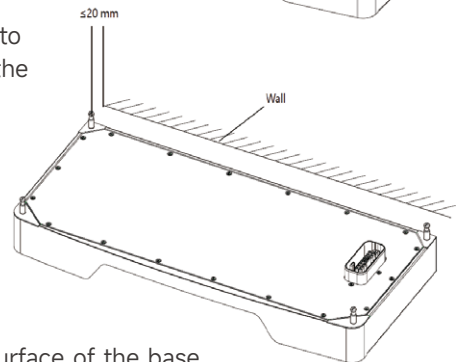

Use a gradienter to level the top surface of the base.



4.5.3 Slave Battery Installation

Install guide pins

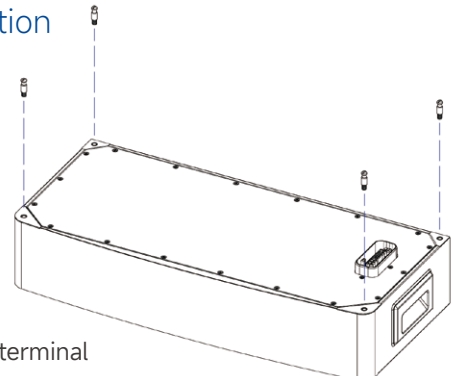

Peel off the protective film on the terminal

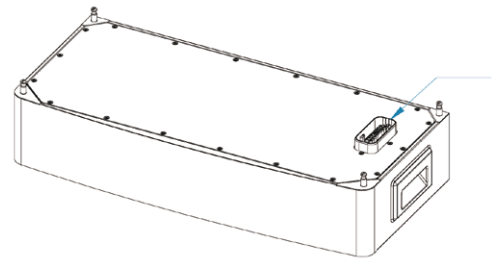

Align the battery box with the base as shown in the figure and install it, pay attention to the level and put it down slowly

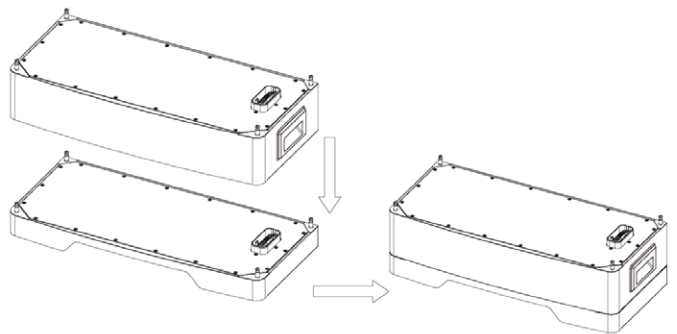

Follow the previous steps to install the slave batteries

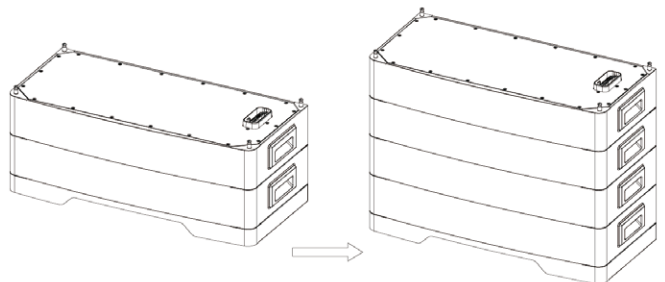

4.5.4 Install the Battery Control Box

Prepare the main control box and the required fixing parts for installation



As shown in the figure, align and install to the slave module horizontally and slowly.

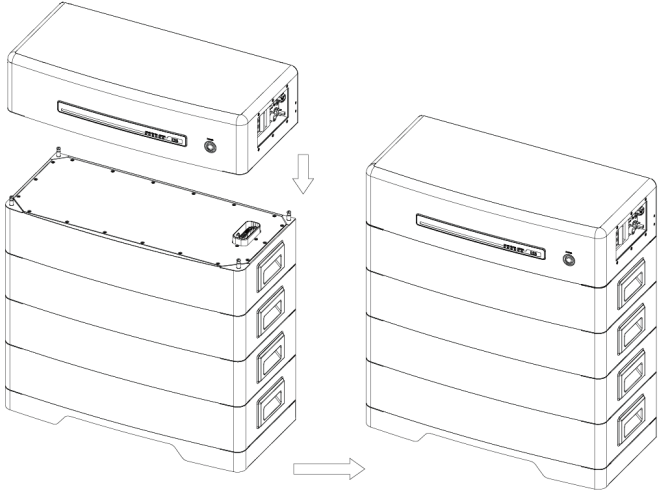

4.5.5 Fix the Product

Prepare the fixing parts as shown in the picture.

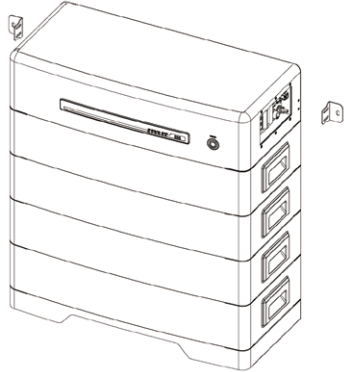

First use the fixing parts to lean against the battery where there are screw holes, and mark on the wall.
Take off the fixing part, use a hole drill to punch holes on the wall according to the mark.
Install the fixing parts, as shown below.

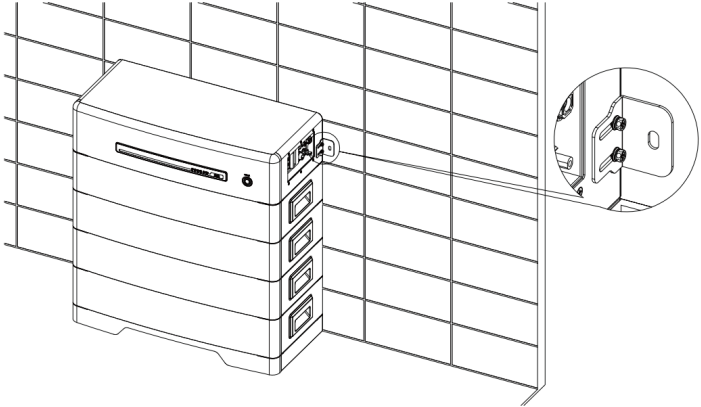

4.6 iBox installation

4.6.1 iBox installation



The iBox can only be installed indoor, far from heat sources.
The iBox should be bolted on the wall with a right angel like bellow.
The iBox should be installed under the following Installation tilts.

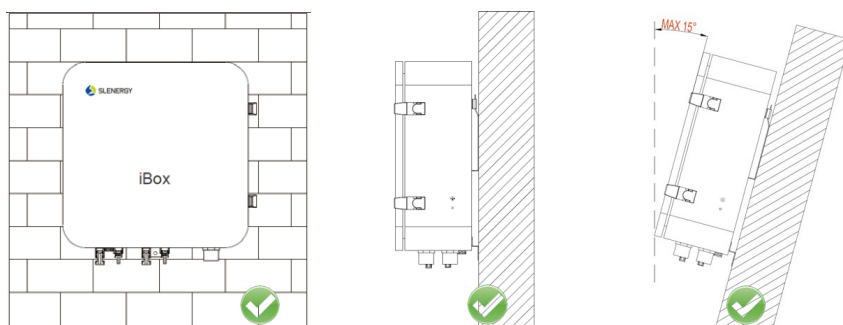

Right installation tilts



Wrong installation tilts

Figure 4.6.1-1 Installation tilts of the iBox

Step 1 Determine the installation positions for drilling holes, and mark the positions using a marker. Drill installation holes on the wall, knock in the wall lugs, mount the Mounting Plate-A. Four installation holes are needed, the distance between holes is like bellow:

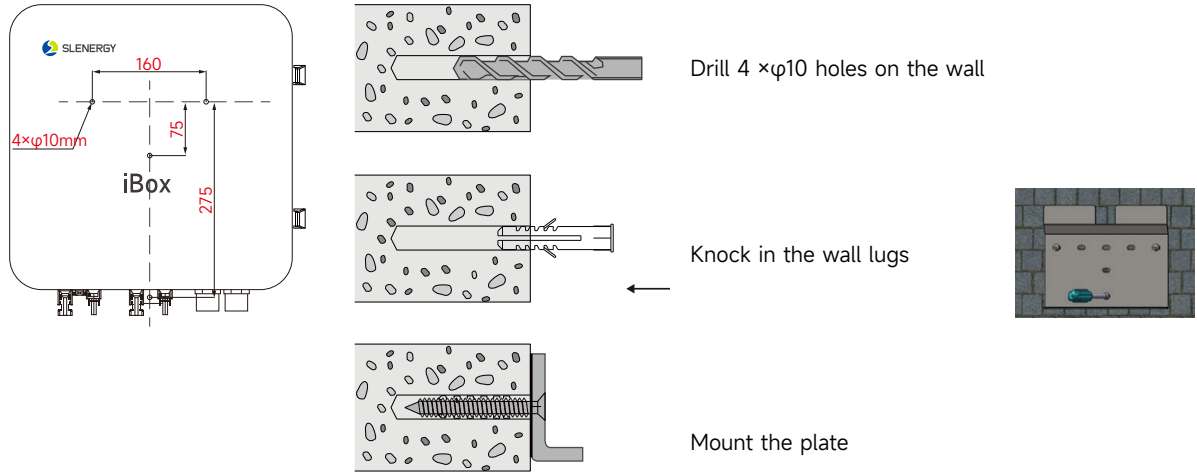

Mark the position of 4 holes with Mounting Plate-A
 Figure 4.6.1-2 Drill holes on the wall and mount the Mounting Plate-A

Step 2 Install the Mounting Plate B&C onto the iBox enclosure.



Figure 4.6.1-3 Install mounting plate on the iBox

Step 3 Hung the iBox onto the back plate, and fasten the plate on the bottom.

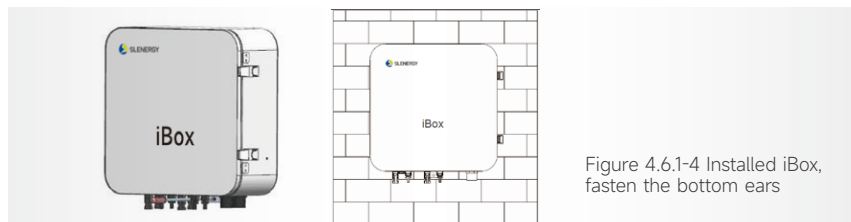
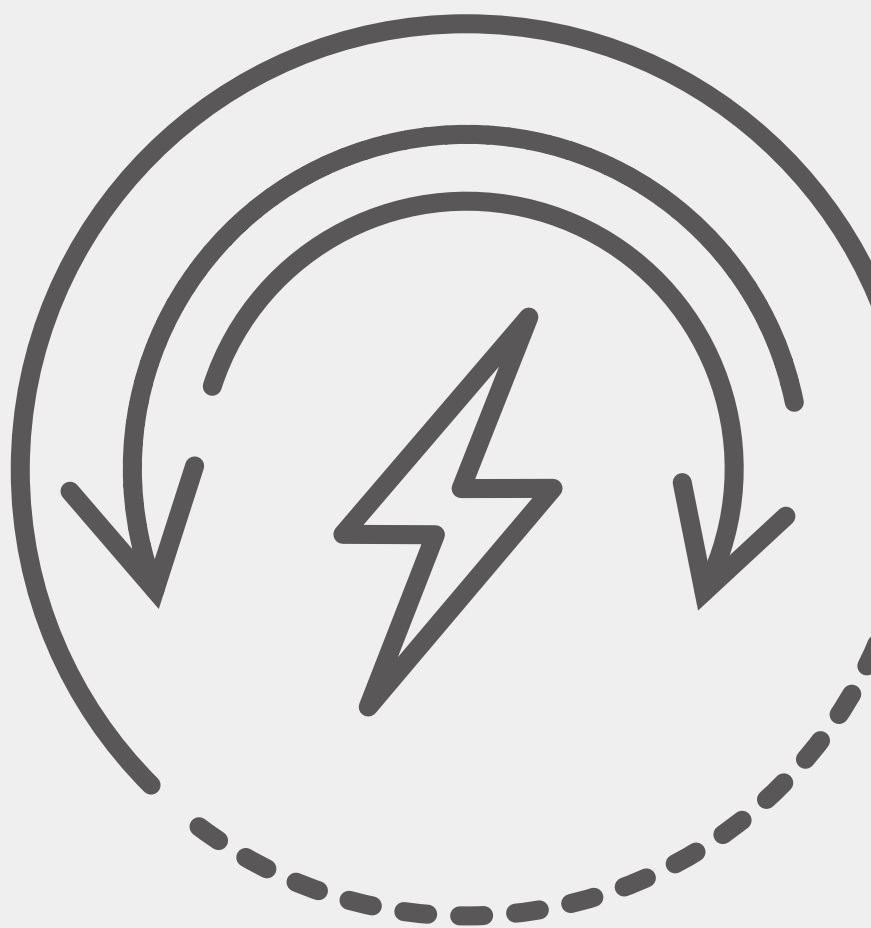

Figure 4.6.1-4 Installed iBox, fasten the bottom ears

5

Electrical Connections



5.1 DC Electrical Connection

5.1.1 Electrical connections of PV modules

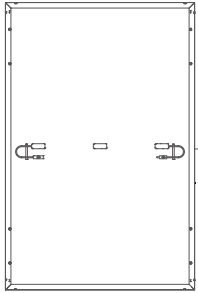
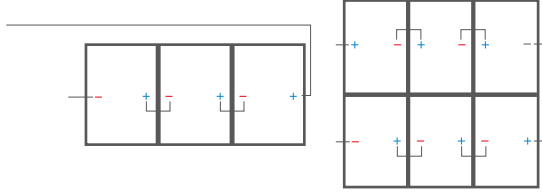
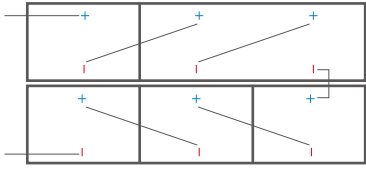
Junction Box Location Icon	Recommended Wiring Method
 <p data-bbox="612 1043 746 1099">Standard cable length: 1.2m</p>	<p data-bbox="847 483 1374 555">Vertical Installation: Standard Cable length (Note: An extension cord is required at the rotor head of the double row assembly and at the end of the single row.)</p>  <hr/> <p data-bbox="847 835 1374 907">Horizontal Installation: It is not recommended to install PV modules horizontally. If it is necessary to install PV modules horizontally, an extension line should be added.</p> 

The electrical performance parameters of the module were tested under standard test conditions, i.e., light intensity of 1000 W/m², AM 1.5, and ambient temperature of 25°C. In some cases, module may produce higher or lower voltage or current values than the rating. When the other modules of the PV system are rated voltage, conductor rated current, fuse size, and the specifications of the control module connected to the output of the solar module, the short-circuit current and open-circuit voltage values marked on the module are multiplied by a factor of 1.25.

All wiring should be performed by qualified installers in accordance with local regulations and procedures.



Inverter: Please be aware the number of PV modules in one string might be between 5-12.

The optimal number of PV modules in one string is 8-12.

5.1.2 Assembling the PV Connector

- Make sure that the connectors are securely connected and properly connected. The connectors must not be subjected to external pressure. The connectors can only be used for circuit connection functions and should not be used to turn the circuit on and off. Connections should be kept dry and clean to prevent rain and moisture. Avoid direct sunlight and water soaking of the connector.
- Insert the positive and negative cables into the corresponding positive and negative connectors, pull back the DC cable to ensure that the terminal is tightly attached in the connector.
- Use an open-end wrench to screw the nut to the end to ensure that the terminal is well sealed.
- The connector does not have any waterproof function before docking. When installing the module, it is necessary to dock the connector as soon as possible or take waterproof measures to prevent the connector from being exposed to moisture and dust.
- When connecting in series, the solar modules with the same gear current must be selected for connection. The voltage of the module connected in series cannot be higher than the maximum voltage allowed by the system. The number of modules per string depends on the system design, inverter type and environmental conditions.
- The maximum rated fuse current value of each string of module is identified in the product label and specification sheet. The rated fuse current corresponds to the maximum reverse current value of the module. Based on the maximum fuse current and local electrical performance installation requirements, match the appropriate fuse to protect the series-parallel module in the circuit.



High voltage may be present in inverter!

Ensure all cables are voltage-free before performing electrical operations. Do not connect the DC switch and AC circuit breaker before finishing electrical connection.



For best practice, ensure PV modules of the same model and specifications are connected in each string.



PV Max. Input voltage is 950V without battery, or 850V with battery, otherwise inverter will be waiting.

5.1.2.1 PV Side Requirements

System Layout of Units with external DC Switch

1 Local standards or codes may require PV systems that fit with an external DC switch on the DC side. The DC switch must be able to safely disconnect the open-circuit voltage of the PV array plus a safety reserve of 20%. Install a DC switch to each PV string to isolate the DC side of the inverter.

2 The DC switch has to be certified by AS 60947.3:2018 and AS/NZS IEC 60947.1:2020 in Australia and New Zealand market. The Max. current of the DC switch matching with SL-D3~8KTL inverter is no less than 40A. We recommend the following electrical connection.

5.1.2.2 DC Connector



Before assembling the DC connector, make sure that the cable polarity is correct.

1 Peel off the DC cable insulation sleeve for 7 mm.

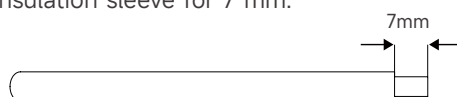

2 Disassemble the connector in the accessory bag.

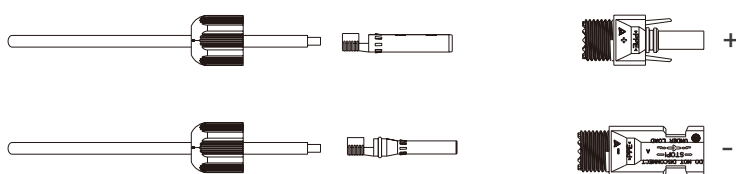

3 Insert the DC cable through the DC connector nut into the metal terminal and press the terminal with a professional crimping plier (pull back the cable with some power to check if the terminal is well connected to the cable).

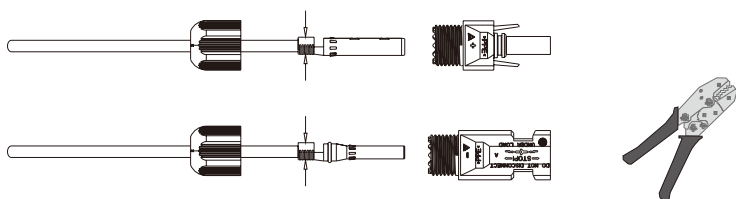

4 Insert the positive and negative cables into the corresponding positive and negative connectors, pull back the DC cable to ensure that the terminal is tightly attached in the connector.

5 Use an open-end wrench to screw the nut to the end to ensure that the terminal is well sealed.

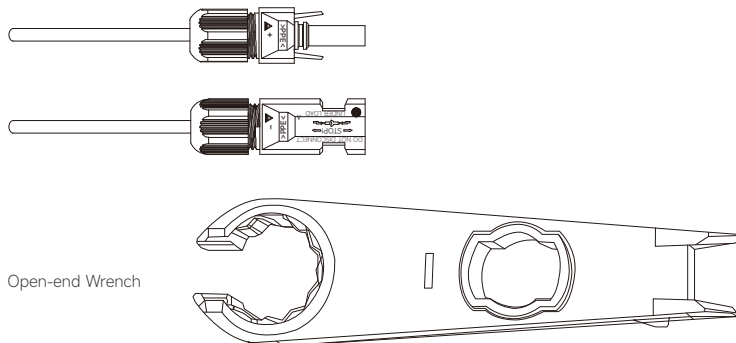

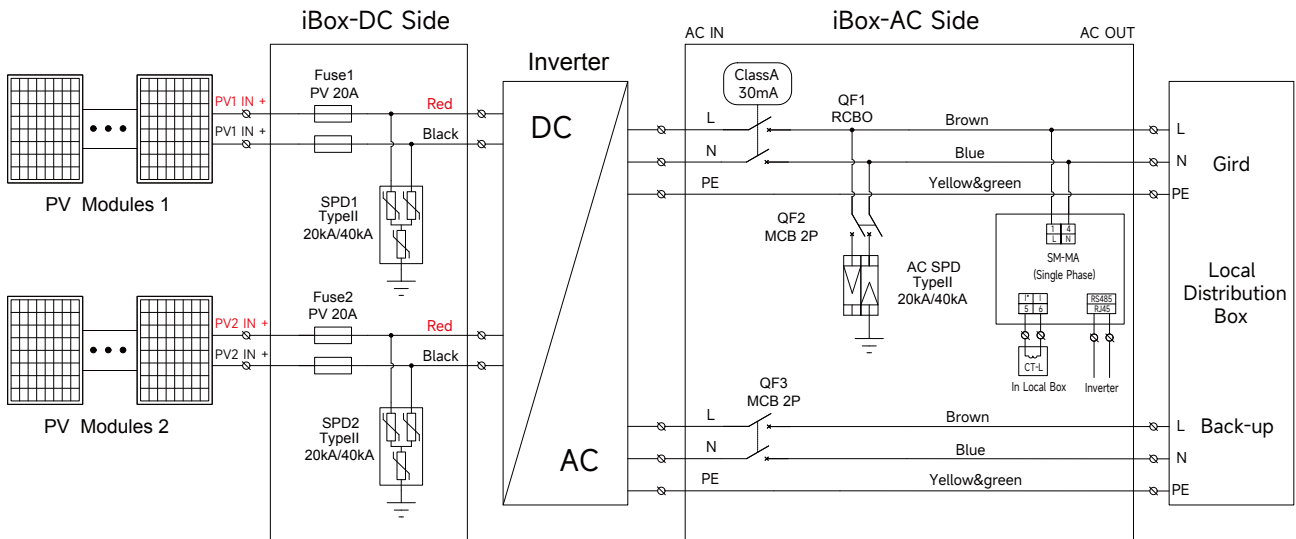

5.1.2.3 DC Connection

Rotate the DC switch to "OFF" position.

①

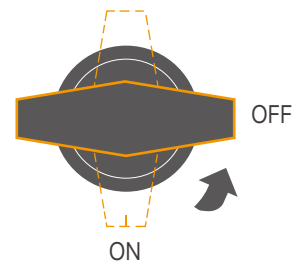

Check the cable connection of the PV string for polarity correctness and ensure that the open circuit voltage in any case does not exceed the inverter input limit of 1,000V.PV Max. Input voltage is 950V without battery, or 850V with battery, otherwise inverter will be waiting.

②

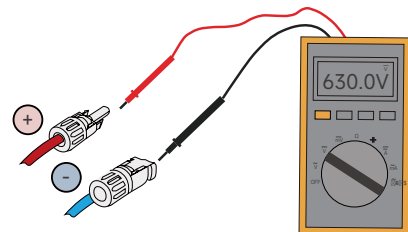

3) Insert the positive and negative connectors of H1Z2Z2-K 1×6mm² into the iBox PV input terminals respectively, a click sound should be heard if the terminals are well connected.

③

↓
④

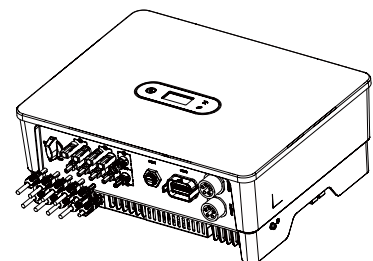

4) Insert the positive and negative connectors of UL11627 10AWG respectively from iBox PV output to inverter PV input.

④ Seal the unused PV terminals with the terminal caps.

5.2 AC Electrical Connections



A high voltage in the conductive part of the inverter may cause an electric shock. When installing the inverter, make sure that the AC and DC sides of the inverter are completely de-energized.

~~Do not connect the N-wire as a protective ground wire to the inverter casing. Otherwise, it may cause electric shock.~~



Do not ground the positive or negative pole of the PV string, otherwise it will cause serious damage to the inverter

Static may cause damage to the electronic components of the inverter. Anti-static measures should be taken during installation and maintenance.



Do not use other brands or other types of terminals other than the terminals in the accessory package. Slenergy has the right to refuse all damages caused by the mixed-use of terminals.

Moisture and dust can damage the inverter, ensure the cable gland is securely tightened during installation. The warranty claim will be invalidated if the inverter is damaged as a result of a poorly connected cable connector.

5.2.1 Electrical Wiring Diagram

This diagram shows iShare SL-D3-8KTL series hybrid inverter wiring structure and composition, concerning the real project, the installation and wiring have to be in line with the local standards.

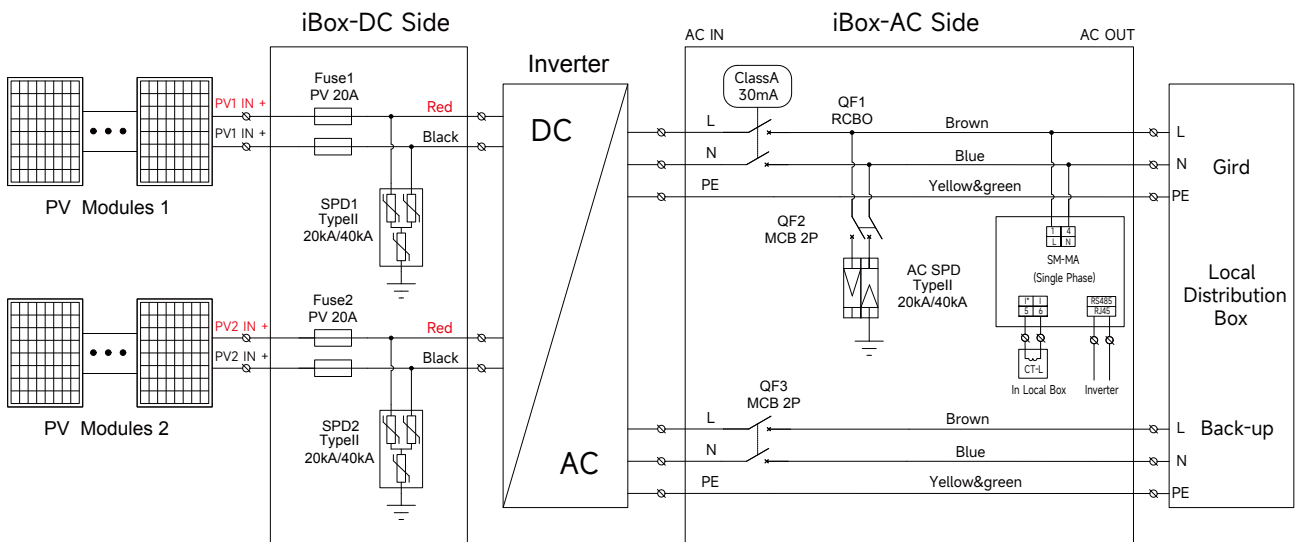
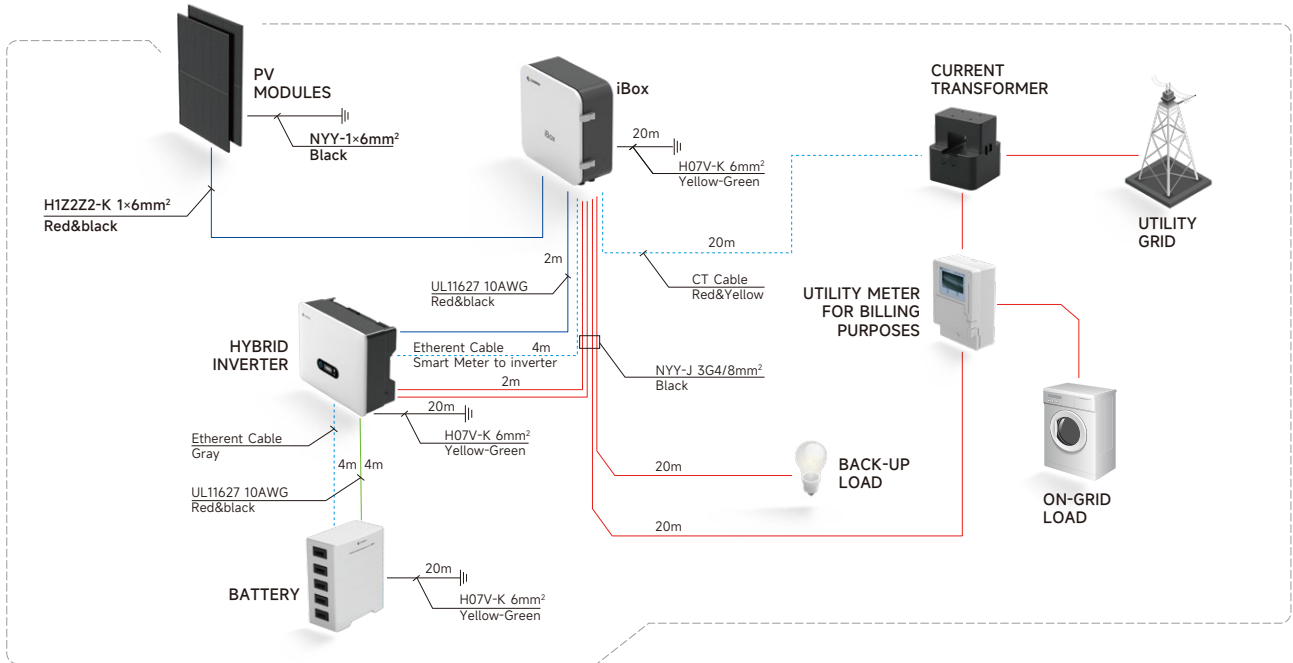

5.2.2 AC Connection

5.2.2.1 AC Side Requirements



- An independent AC breaker is required in both on-grid and back-up output side, and any loads cannot be connected with inverter directly.
- Before making the connection of AC cable, please confirm all DC & AC power source are disconnected from the inverter.
- The 3-8kW series single-phase high voltage hybrid inverter applies to the single-phase power grid with a voltage of 230V and a frequency of 50/60Hz.
- Connect the inverter to the grid only after getting an approval from the local electric power company.

A single-phase AC breaker needs to be installed on the AC side of the SL-D3-8KTL. To ensure that the SL-D3-8KTL can safely disconnect itself from the power grid when an exception occurs, select a proper overcurrent protection device in compliance with local power distribution regulations and Max. input (output) current of SL-D3-8KTL AC side.



Determine whether an AC circuit breaker with greater overcurrent capacity is required based on actual conditions.

Residual Current Monitoring Device

With an integrated universal current-sensitive residual current monitoring unit included, the inverter will disconnect immediately from the mains power once a fault current with a value exceeding the limit is detected.

However, if an external residual current device (RCD) is mandatory, the switch must be triggered at a residual current of 300 mA (recommended), or it can be set to other values according to local regulations. For example, in Australia, the inverter can use an additional 30mA (type A) RCD in installations.

5.2.2.2 Installing the AC Connector



High voltage may be present in inverter!

Ensure all cables are voltage-free before electrical connection. Do not connect the AC circuit breaker until all inverter electrical connections are completed.

Connect the On-grid AC cable to the iBox AC OUT terminal, then connect the iBox AC IN terminal to the inverter On-grid terminal, and rotate the AC connector buckle clockwise until its tight enough.

Connect the Backup AC Cable to the iBox Backup OUT terminal, then connect the iBox Backup IN to the inverter Backup OUTPUT terminal, and rotate the AC connector buckle clockwise until its tight enough.

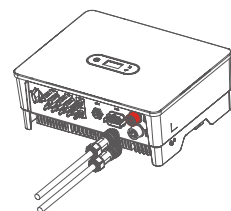

Please distinguish the on-grid and back-up port, and don't mix up the on-grid port and back-up port when making the connection.

5.2.3 Monitoring Device Installation

Slenergy SL-D3-8KTL series hybrid inverter supports WIFI, LAN, and 4G communication. Plug the WIFI, LAN, or 4G module into the COM1 port in the bottom of inverter. A slight "click" sound during the installation represents that the assembly is in place.

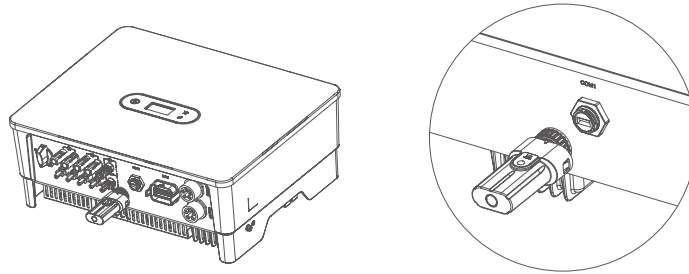

Figure 5.2.3-1 Monitoring device installation

5.5 Communication Connection

5.5.1 Meter and CT Connection

The current Transformer, also called CT, is usually installed on the L wires between the house loads and the power grid.

The Meter is installed in the iBox. CT cable with length of 20m, it can't be extended. Please follow the wiring diagram in the Meter to connect CT.

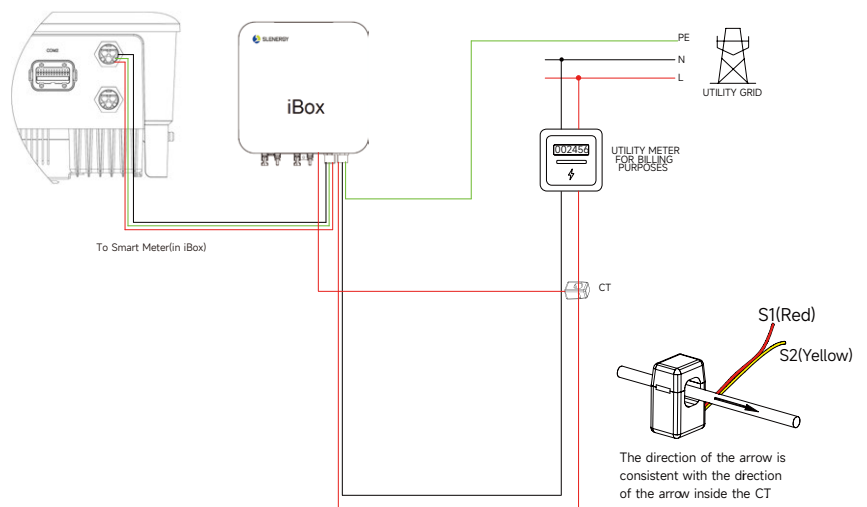

CT installation direction should strictly follow the instruction in the user manual, otherwise, the inverter may not be working normally. The CT has to be corresponding with the port in the meter, and the connection between CT and Meter needs to be reliable, otherwise, the CT measurement accuracy may be affected.

Meter terminals definition as shown in table below:

No.	Definition	Function
1	L	
2	/	L/N connect to grid to detect power grid voltage.
3	/	
4	N	
5	L-S1	
6	L-S2	
7	/	To detect the CT current and direction.
8	/	
9	/	
10	/	
11	PE	Ground Connection
	RS485-1	/
	RS485-2	Communicate with hybrid inverter

All communication ports are in the multifunction communication Port at the bottom of inverter which including Meter port, CAN port, BMS port, EMS port, RLYOUT port, DRED port.

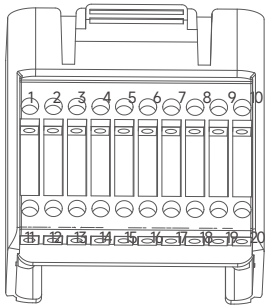
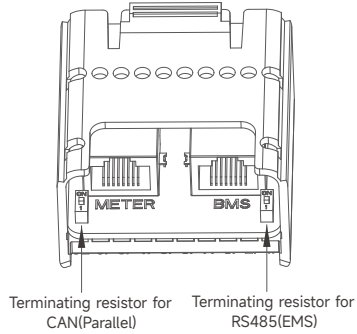

Pin	Definition	Function
RJ45-1	RS 485	Communicate with Meter
RJ45-2	CAN	Communicate with BMS
1	COM	Multifunction Relay
2	NO (Normally Open)	
3	/	Reserved
4	/	Reserved
5	DRM4/8	
6	DRM3/7	DRED for Australia and New Zealand
7	DRM2/6	RCR For Germany and some other European
8	DRM1/5	countries
15	COM D/0	
16	REF D/0	
11	Fast stop +	Fast stop
12	Fast stop -	
13	485 B1	EMS
14	485 A1	
17	CANL_P	CAN for parallel connection of inverters
18	CANH_P	
19	/	Reserved
20	/	Reserved

5.5.2 Inverter Communication Connection

5.5.2.1 Assembling the Multi-com Connector

1. Unscrew the swivel nut from the connector.

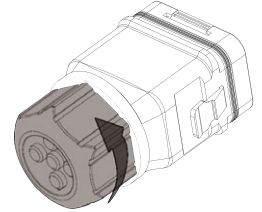

2. Take out the terminal block.

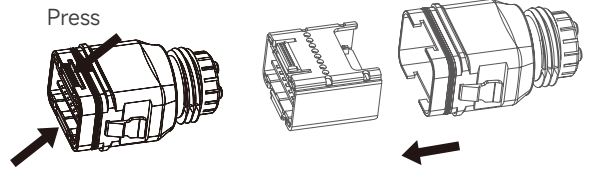

3. Remove the seal and lead the cable through the cable gland.

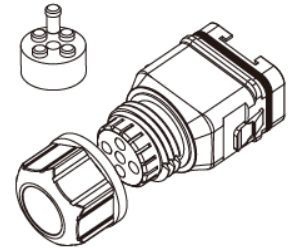

5.5.2.2 Connect the Meter And BMS Communication Cables



The communication between meter/BMS and inverter is RJ45 interface cable.

1. Thread the RJ45 plug of appropriate length through the swivel nut, and insert it into the open side of the rubber gasket.

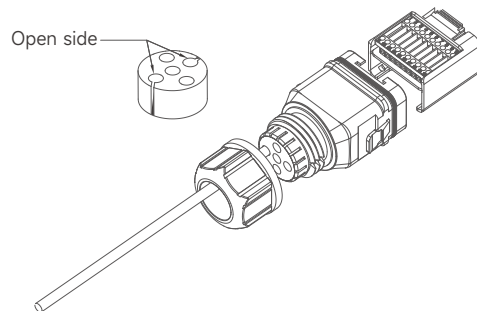

2. Insert one side of the RJ45 plug into the RJ45 port of terminal block.

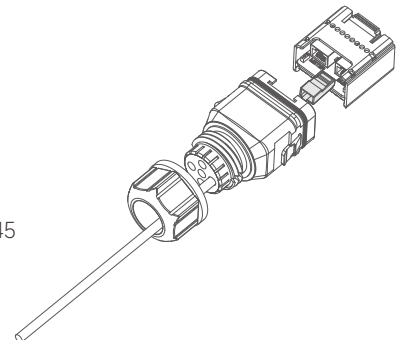

3. Insert another side of the communication cable into the meter RS485 port or BMS CAN port.

5.2.5.3 Connect Other Cables

Thread the cable of appropriate length through the swivel nut and the housing. Remove the cable jacket and strip the wire insulation.

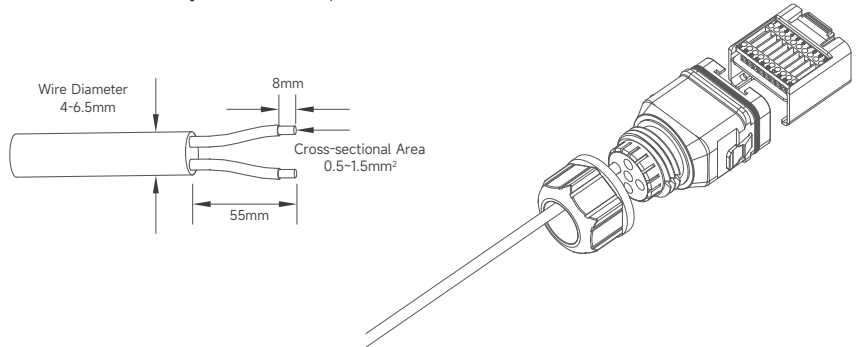

(Optional) When using a multi-core multi-strand copper wire cable, connect the AC wire head to the cord end terminal (hand-tight). In case of single-strand copper wire, skip this step.

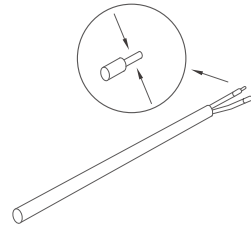

Fix all the wires to the terminal plug according to the assignment and tighten to a torque of $1.2 \pm 0.1 \text{ N} \cdot \text{m}$ with a screwdriver.

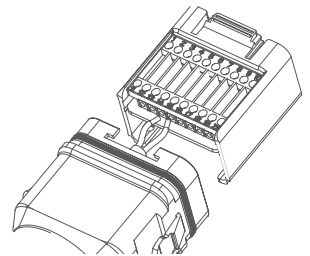

Pull the wires outward to check whether they are firmly installed.

Insert the terminal block into the connector until it snaps into place with an audible click.

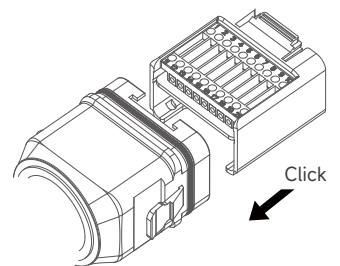

Fasten the swivel nut.

$2.5 \pm 0.1 \text{ N} \cdot \text{m}$

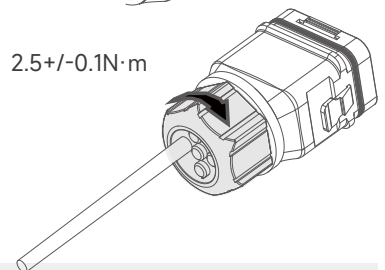



NOTICE

Connect Inverter COM2 Meter port to iBox RS485 port.

5.2.5.4 Installing the COM Connector

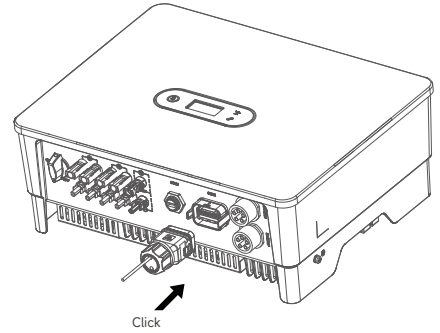
- Remove the waterproof lid from the COM terminal.
- Insert the COM connector into COM terminal on the bottom of the inverter until there is an audible click.



5.5.2.5 Meter and BMS Communication

RJ45 terminal connection sequence and definition as below.

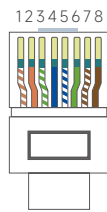

No.	Color	Meter Side	Battery Side
1	Orange & White	/	RS485_A3
2	Orange	/	RS485_B3
3	Green & White	RS485_B2	/
4	Blue	/	CANH_B
5	Blue & White	/	CANL_B
6	Green	RS485_A2	/
7	Brown & White	RS485_B2	/
8	Brown	RS485_A2	/

RJ45 terminal connection sequence and definition

5.5.2.6 DI Ctrl

DRM and Ripple Control support only one function at the same time.

DRM

DRED (Demand Response Enabling Device) interface is special reserved for Australia and New Zealand according to their safety regulation, and Slenergy doesn't provide the DRED device for the customer. The inverter supports the demand response modes as specified in the standard AS/NZS 4777. The inverter has integrated a terminal block for connecting to a DRED.

DRED wiring diagram (hybrid inverter) as below:

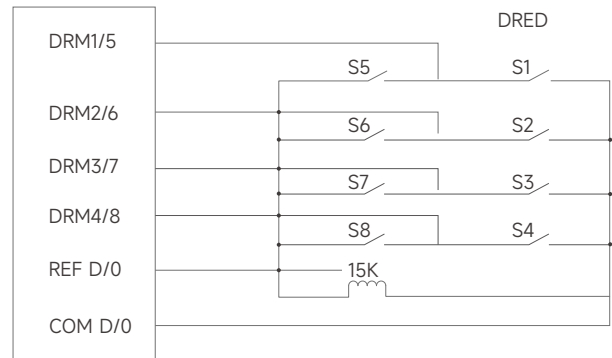

DRED mode as shown in table below:

Mode	Function
DRM 0	Operate the disconnection device
DRM 1	Do not consume power
DRM 2	Do not consume at more than 50% of rated power
DRM 3	Do not consume at more than 75% of rated power and source reactive power if capable
DRM 4	Increase power consumption (subject to constraints from other active DRMs)
DRM 5	Do not generate power
DRM 6	Do not generate at more than 50% of rated power
DRM 7	Do not generate at more than 75% of rated power and sink reactive power if capable.
DRM 8	Increase power generation (subject to constraints from other active DRMs)
Priority	DRM1 > DRM2 > DRM3 > DRM4 DRM5 > DRM6 > DRM7 > DRM8



There is a resistor between 15(COM D/0) and 16(REF D/0), do not move the resistor while wiring.

RCR

RCR (Ripple Control Receiver) interface is special reserved for Germany and some other Europe-an country according to their safety regulation, and Slenergy doesn't provide the RCR device for the customer.

In Germany and some European areas, a ripple control receiver is used to convert a power grid dispatching signal to a dry contact signal. The dry contact is required for receiving the power grid dispatching signal.

RCR wiring diagram (hybrid inverter) as below:

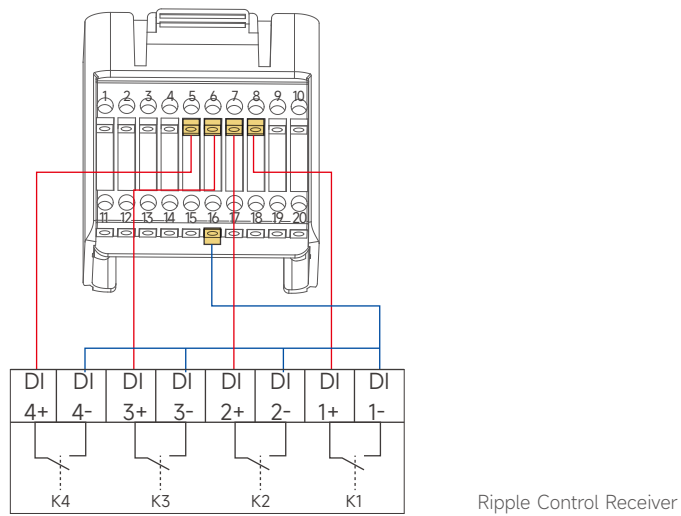

RCR operation mode as shown in table below:

Switch mode (External RCR device)	Feed-in output power (in % of the Rated AC output power)
K1 turn on	100%
K2 turn on	60%
K3 turn on	30%
K4 turn on	0%
RCR priority: K1<K2<K3<K4	

5.5.2.7 Multifunction Relay

The inverter is equipped with a multifunction dry contact relay, which helps turn the loads on or off when an extra contactor is connected, or startup the diesel generator when the diesel generator startup signal is connected.



Maximum voltage and current at DO dry contact port:
230VAC 1A/ 30VDC 1A.



For more installation and setup information, please contact Slenergy.

Load Control

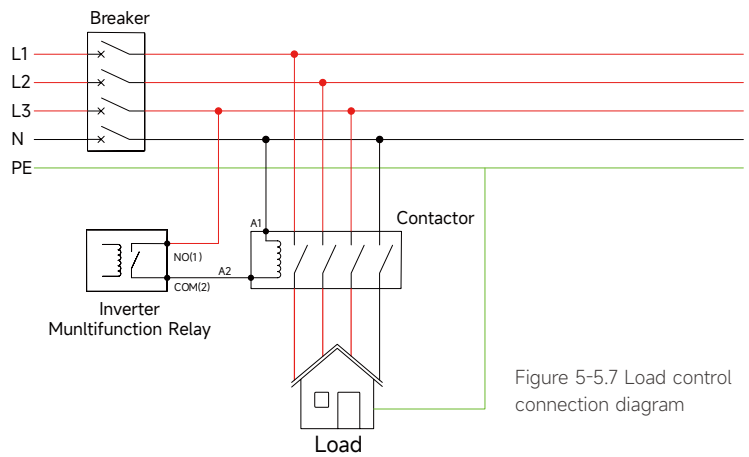

Figure 5-5.7 Load control connection diagram



The AC contactor should be placed between the inverter and the loads. Do not connect the load to DO port directly. The contactor is not supplied by the Slenergy. Connect the load to the DO port of the inverter directly if the load is designed with a DI port. When the controlled load is connected to ONGRID, the contactor coil must also be connected to ONGRID. When the controlled load is connected to BACKUP, the contactor coil must also be connected to BACKUP.

Generator Control

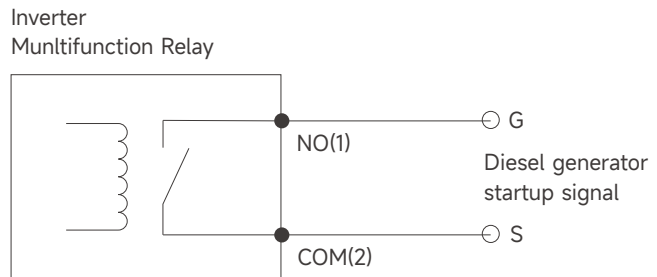
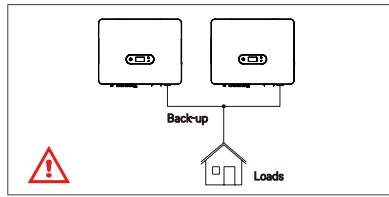

Figure 5-26 Generator Control connection diagram

When the "GEN signal" is active, the open contact (GS) will switch on (no voltage output).

5.5.2.8 Parallel System



For the general version, back-up cannot connect in parallel. For advanced applications, please contact our after-sales department.

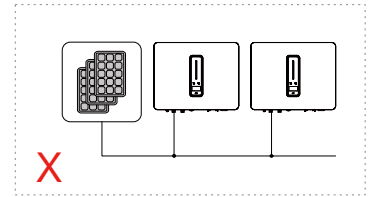

Single PV string cannot connect to multiple inverters.

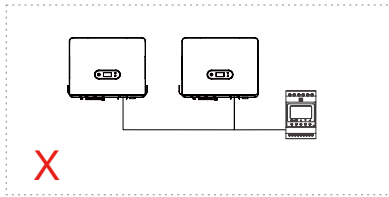

One meter cannot be connected to multiple inverters. Different CTs cannot connect to the same line cable.

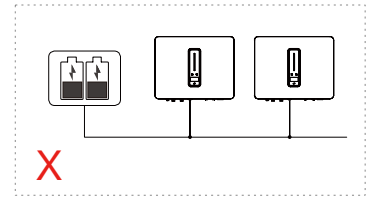

One battery bank cannot be connected to multiple inverters.

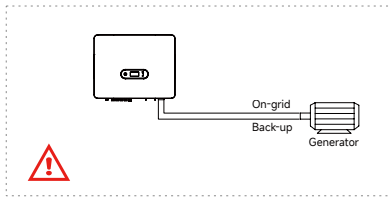

The on-grid and back-up side cannot be connected to and generator directly. For advanced applications, please contact our after-sales department.

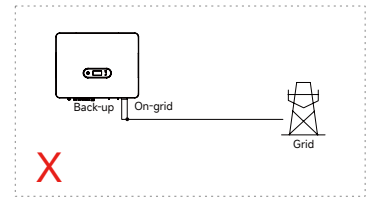

The back-up side cannot be connected on-grid side or grid.

 **NOTE** For more installation and setup information about parallel system, please contact Slenergy.

5.5.2.9 Fast stop

Slenergy SL-D3-8KTL hybrid inverter comes standard with fast stop function, and you can use this function by connecting an external switch into the fast stop interface if it requires in the installation place. The external switch doesn't include in our accessory box.

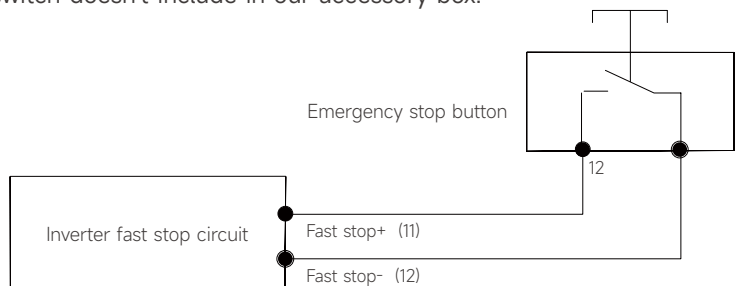

Figure 5-28 Fast stop connection diagram

5.5.3 EMS Communication

An EMS communication cable needs to be connected when to control the operation of a hybrid inverter through the EMS, and communication between EMS and inverter is RS485.

5.6 Power Cable of the Battery Connection

5.6.1 The following principles must be considered when making battery connection:

- 1 Disconnect the AC breaker on the grid side.
- 2 Disconnect the breaker on the battery side.
- 3 Turn the inverter DC switch to the "OFF" position.
- 4 Make sure the maximum input voltage of battery is within the inverter limitation.

Insert the positive and negative connector into the inverter battery terminals respectively, and a "click" sound represents the assembly in place.

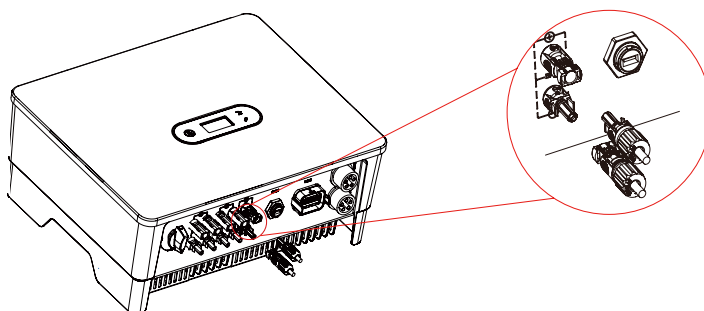

5.7 Battery electrical connections



A high voltage in the conductive part of the battery may cause an electric shock. When installing the battery, make sure that the DC sides of the battery is completely deenergized.

Do not ground the positive or negative pole of the battery output, otherwise it will cause serious damage to the battery.

Static may cause damage to the electronic components of the battery. Anti- static measures should be taken during installation and maintenance.

Do not use other brands or other types of terminals other than the terminals in the accessory package. Slenergy has the right to refuse to held liable of all damages caused by the mixed-use of terminals.

Moisture and dust can damage the battery, ensure the cable gland is securely tightened during installation. The warranty claim will be invalidated if the battery is damaged as a result of using poorly connected cable connector.

5.7.1 Cables Connection

After the mechanical installation is completed, please connect the inverter and the control battery module with the positive and negative cables, communication and ground cables.

Check if the switch is off

Connect the grounding wire H07V-K 6mm²

6

Commissioning



6.1 Check Before Power-On

Table 6.1-1 Installation checklist



Please check the installation again before turning on the system.

No.	Check Item	Acceptance Criteria
1	Cable layout	Cables are routed properly as required by the customer.
2	Cable tie	Cable ties are secured evenly, and no burr exists.
3	Grounding	The grounding cable is connected correctly, securely, and reliably.
4	Turn off the switches	The DC SWITCH and all the switches connected to the inverter are set to OFF.
5	Cable connections	The AC output power cable and DC input power cable are connected correctly, securely, and reliably.
6	Unused terminals and ports	Unused terminals and ports are locked by watertight caps.
7	Installation environment	The installation space is proper, and the installation environment is clean and tidy, without foreign matter.

6.2 App Preparation

- 1 Install the Local configuration App and Cloud monitoring App with latest version. Refer to "8.1.2 Cloud monitoring App and 8.1.3 Local configuration App".
- 2 Register an account on the Cloud monitoring App. If you have got the account and password from the distributor/installer or Slenergy, skip this step.

6.3 Inspection Before Commissioning

Check the following items before starting the inverter:

- 1 All equipment has been reliably installed.
- 2 DC switch and AC circuit breaker are in the "OFF" position.
- 3 The ground cable is properly and reliably connected.
- 4 The AC cable is properly and reliably connected.
- 5 The DC cable is properly and reliably connected.
- 6 The communication cable is properly and reliably connected.
- 7 The vacant terminals are sealed.
- 8 No foreign items, such as tools, are left on the top of the machine or in the junction box (if there is).
- 9 The AC circuit breaker is selected in accordance with the requirements of this manual and local standards.
- 10 All warning signs & labels are intact and legible.

6.4 Commissioning Procedure

If all of the items mentioned above meet the requirements, proceed as follows to start up the inverter for the first time.

- 1 Turn on the AC breaker.
- 2 Turn on the lithium battery switch. Power on the battery pack manually if a battery is equipped.
- 3 Turn on the DC switch, the DC switch may be integrated in the inverter or installed by the customer.
- 4 The inverter will work properly after turning on the DC and AC breakers on the condition the weather and grid meet requirements. The time for entering the operating mode may vary according to the chosen safety code.
- 5 Observe the LED indicator to ensure that the inverter operates normally.
- 6 After the inverter is started, please refer to the [QUICK USE GUIDE] which is attached to the access to configure the inverter.



NOTE

- If the inverter does not work properly, check the country code and battery ID Settings.
- Select the safety code suitable for the country (region) where the inverter is installed at.
- Select the battery ID suitable for the battery is installed.

CT AUTO TEST FUNCTION

SL hybrid inverter has the function of detecting the installation direction and phase sequence of CT. The system is installed, this function can be enabled on the APP for detection.



NOTICE

SOC RESET FUNCTION

When the inverter is turned on for the first time, the battery will be automatically charged to calibrate the battery SOC. After the battery is charged, this function will be turned off automatically (If you confirm that it is not necessary, you can manually turn off the function. We recommend to enable this function.)

If you need to calibrate the SOC during system use, you can manually enable the function to calibrate the battery SOC on app or inverter screen. After the battery is fully charged, the function is automatically disabled again.

6.5 Stop the Inverter

When turning off the inverter, please follow the steps below:

- 1 Shut down the inverter through the APP or the button on the display first.
- 2 Disconnect the breakers on the grid and load side.
- 3 Turn off the battery switch, and disconnect the DC breaker on the battery side (if any).
- 4 Wait 30 seconds and then turn the inverter DC switch to the "OFF" position. At this time, there is remaining power in the inverter capacitor. Wait for 10 minutes until the inverter is completely de-energized before operating.
- 5 Disconnect the AC and DC cables.

—

7

Operation



When the inverter is turned on, the following interfaces will be displayed on the OLED display, and the OLED display allows the user to check various operation information and to modify the settings of the inverter.

NOTE If the parameter is a number short press to change the number, long press to confirm the number and jump to the next number. Please wait for 10 seconds and the inverter will automatically save your settings or modifications.

7.1 Main Window

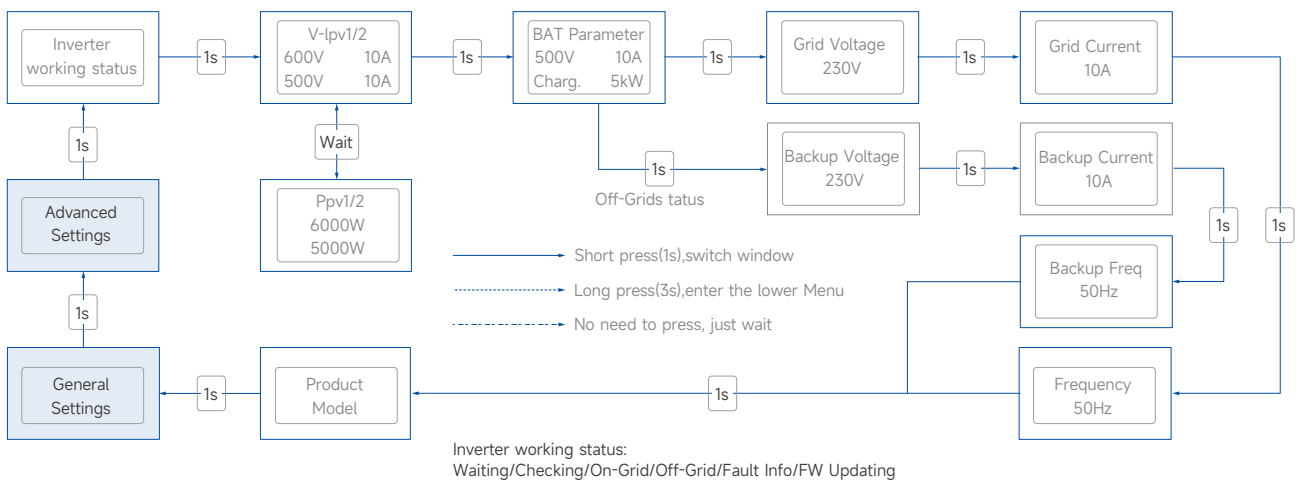

Inverter Display Abbreviation and Complete Name Reference Table

Abbreviation	Complete Name
V-lpv1/2	PV input voltage and current of each MPPT
Ppv1/2	PV input power of each MPPT
BAT Parameter	Battery Parameter
Charg.	Charge
Dischg.	Discharge
Backup Freq	Inverter output Frequency (Off-Grid status)
FW Updating	Firmware Updating

7.2 General Setting

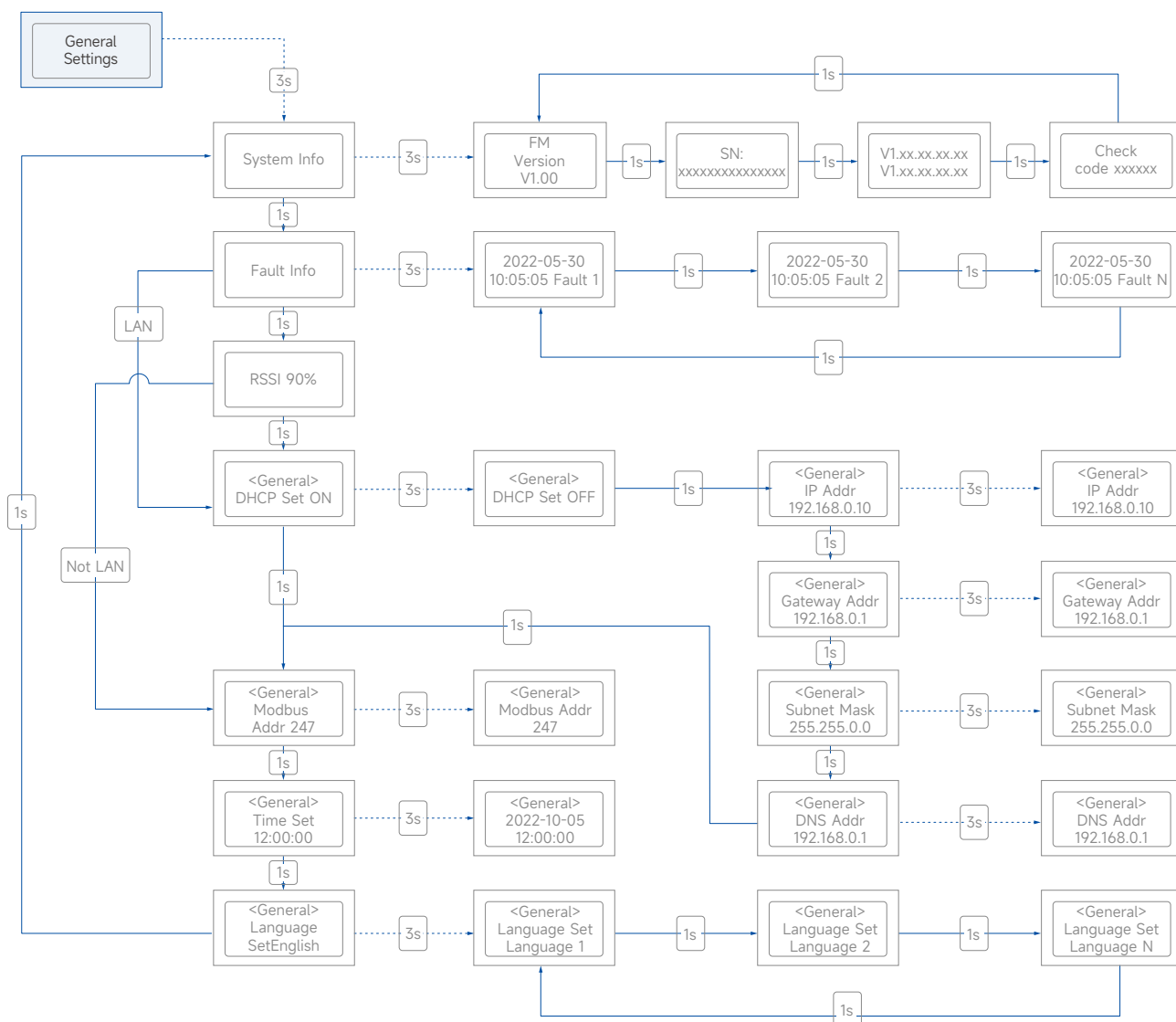

Inverter Display Abbreviation and Complete Name Reference Table

Abbreviation	Complete Name
System Info	System information
FM Version	Firmware version
SN	Series number
Fault Info	Fault information
RSSI	Received signal strength indicator
DHCP Set	Enable or disable DHCP functionality
IP Addr	If DHCP is turned off, set the static IP address
Gateway Addr	If DHCP is turned off, set the Gateway IP address
Subnet Mask	If DHCP is turned off, set the subnet mask
DNS Addr	If DHCP is turned off, set the domain name server address
Modbus Addr	Modbus address

7.3 Advanced Setting

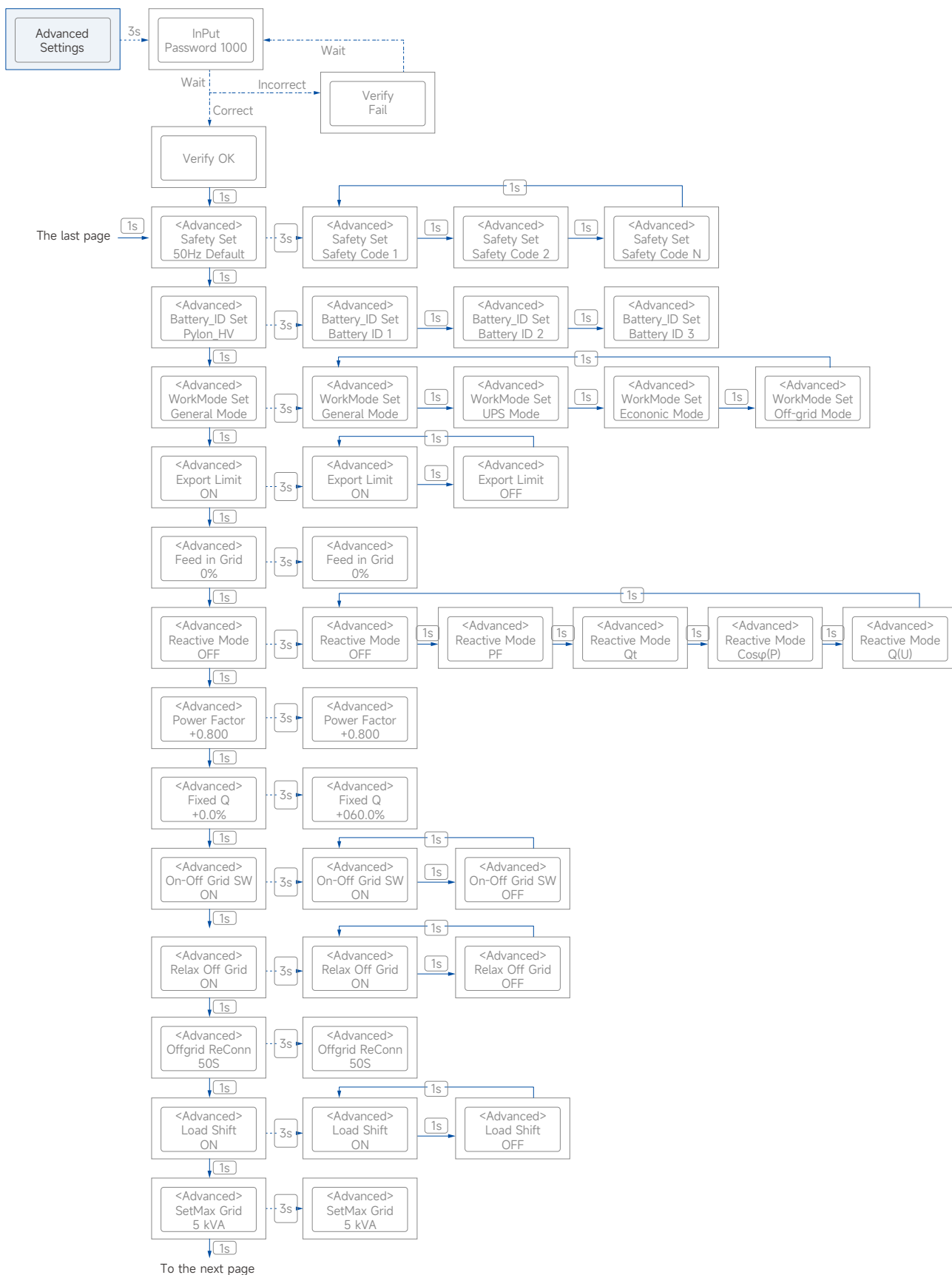

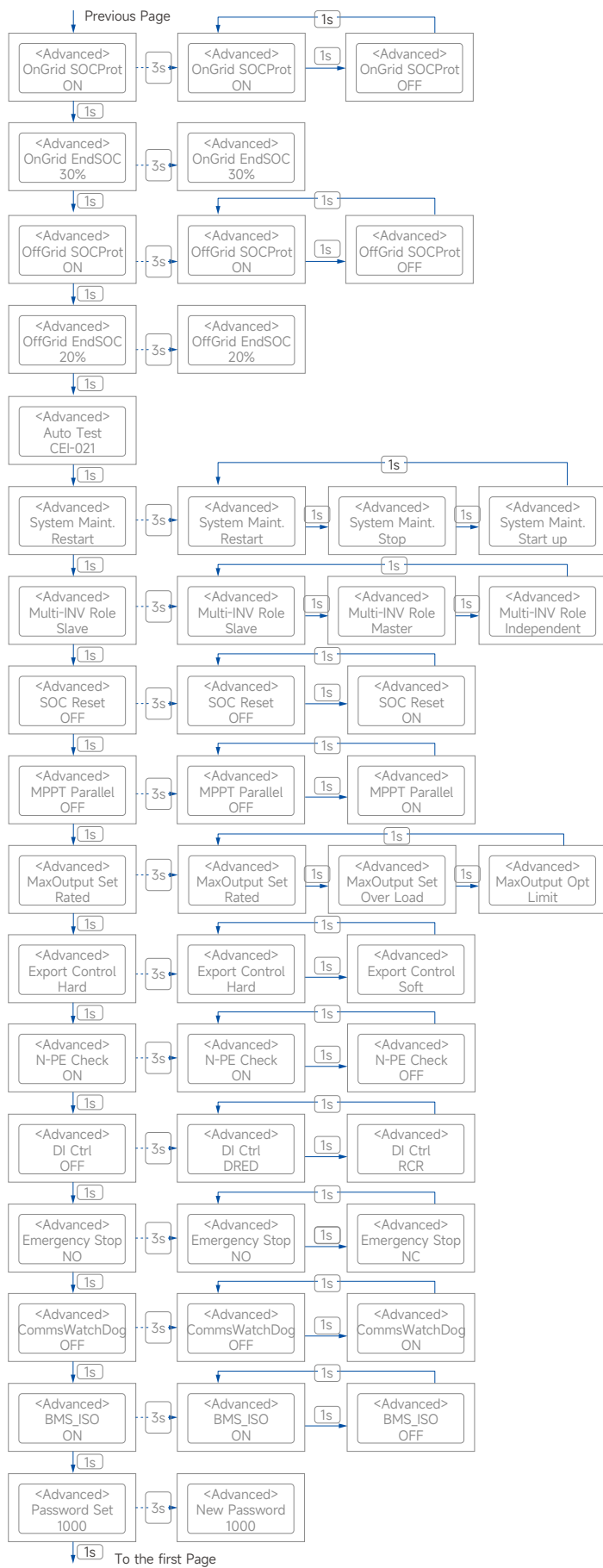

Inverter Display Abbreviation and Complete Name Reference Table

Abbreviation	Complete Name
Safety Set	Select the code that meet local regulatory requirements
Battery_ID Set	Select the battery model
Work Mode	Current work mode / work mode setting
Export Limit	On-grid export limit function switch
Feed in Grid	Set the percentage of the power that is allowed to feed to the grid
Reactive Modes	Reactive Power Mode
PF	"Under ""Reactive Mode" "The reactive power can be regulated by the parameter PF (Power Factor)."
Qt	"Under ""Reactive Mode" "The reactive power can be regulated by the parameter Q-Var limits (in %)."
Cosp(P)	"Under ""Reactive Mode" "The PF changes with the output power of the inverter."
Q(U)	"Under ""Reactive Mode" "The reactive power changes with the grid voltage"
Fixed Q	The reactive power ratio when the "Reactive Mode" is Qt.
On-Off Grid SW	Off-grid function switch (If turn it on, the inverter will automatically switch to off-grid mode to ensure the back-up side power supply when the grid is abnormal or off, otherwise, there is no output on the back-up side)
Relax OffGrid	Reduce the switching sensitivity of the On/Off-grid (applied to the places where the grid is unstable or inverter always entered off-grid mode for some reasons)
Offgrid ReConn.	When inverter is operating without grid, it will stop backup output after overload protection, and restart within the set time.
Load Shifting	Peakload shifting function switch
SetMaxGrid	Set max allowed power from grid (under the condition of Peakload Shifting is on)
OnGrid SocProt.	On-grid battery SOC (State of Charge) Protection
OnGrid EndSOC	End-of-discharge SOC of on-grid
OffGrid SocProt.	Off-grid SOC Protection
OffGrid EndSOC	End-of-discharge SOC of off-grid
Unbalan. Output	3-Phase Unbalanced Output Switch when inverter work on On-grid state



Abbreviation	Complete Name
System Maint.	System maintenance, includes inverter stop and run, system restart
Multi-INV Role	In the multi-inverter parallel system, set the role of one inverter as the master and the other inverter as the slave.
SOC Reset	If turned it on, the battery will be automatically charged to calibrate the battery SOC. After the battery is charged, this function will be turned off automatically
MPPT Parallel	If MPPT is connected in parallel, enable this function.
Max Output Set	Select the maximum AC output power. Rated, Max. output power=Rated output power on the datasheet. Overload, Max. output power= Max. output power on the datasheet. Limit, Max. output power < Rated output power on the datasheet.
Export Control	In the power export limit on mode, when the communication between the inverter and meter or the inverter and datalogger is interrupted, select the inverter operation mode from one of the follows: Hard, inverter stops; Soft, inverter generates power as the "Feed in Grid" value set on the screen
N-PE Check	The N and PE shorting function on the BACK-UP side in the off-grid operation status.
CommsWatchDog	When the function is turned on, the inverter stops working when communication with the master is lost.

7.4 Country Code (Safety Code) Setting

Please set "Country code (Safety code)" under the menu "Safety Set" in "Advanced Settings". Refer to "7.3 Advanced Setting" for more information.

7.5 Auto-Test

This function is disabled by default, and will be only functional in the safety code of Italy. Short press the button several times until "Auto Test CEI 0-21" displays on the screen, press and hold the button 3 seconds to activate "Auto Test". After the auto test is finished, short press the button several times until the screen displays "Auto Test Record", and hold the button 3 seconds to check the test results.

The auto test will start when the correct test item is selected, and the test result will be displayed on the screen when it finished. If the test was successful, it will display "Test Pass", otherwise will display "Test Fail". After each item tested, the inverter will reconnect to the grid and automatically start the next test according to the requirements of CEI 0-21.

Connect the AC cable, auto test will start after the inverter connected to the grid, see the operation steps below:

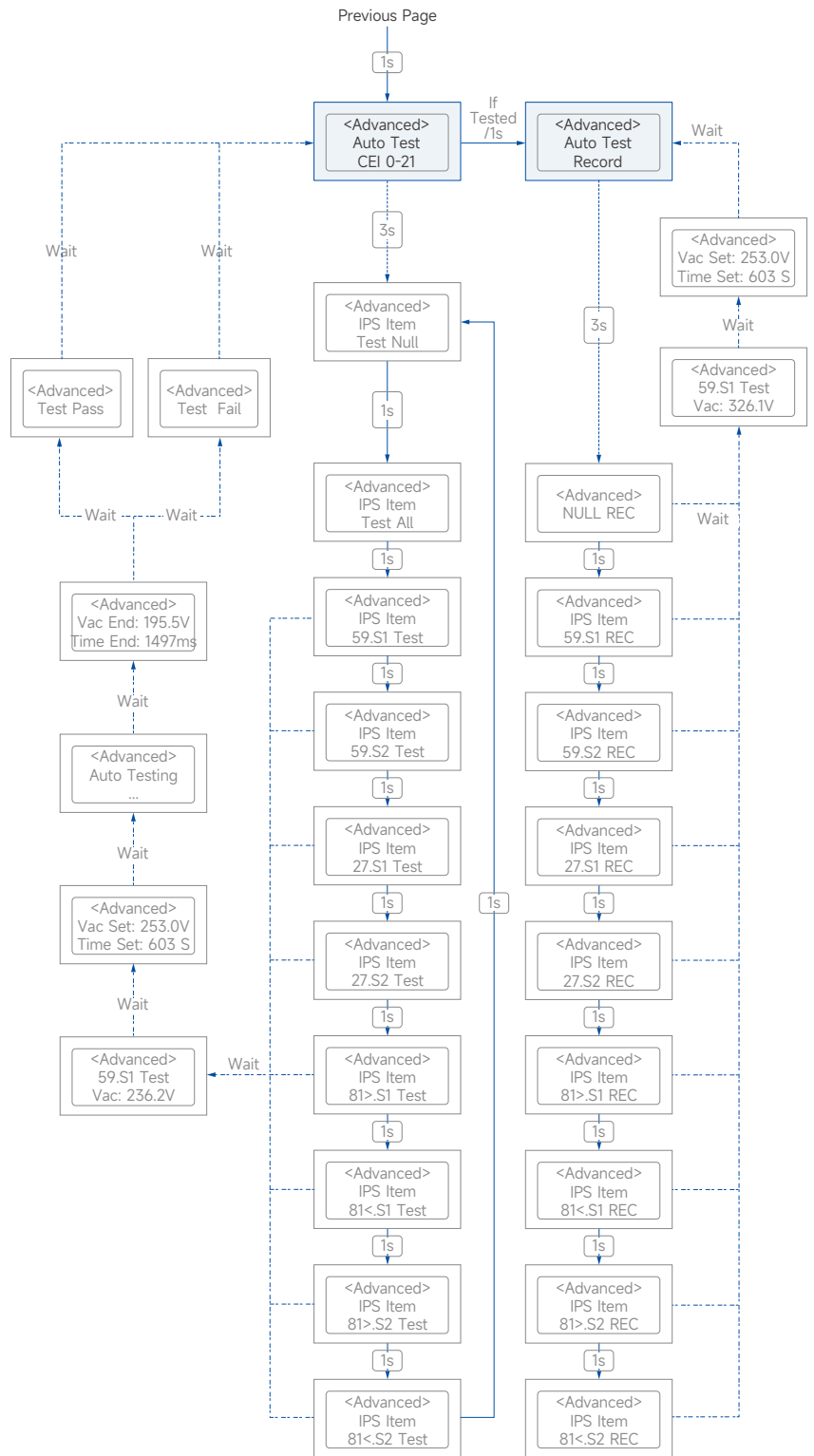

7.6 Reactive Power

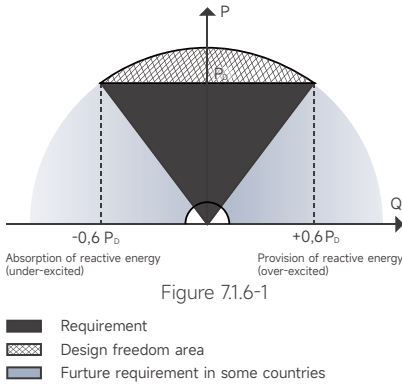

The inverter provides a reactive power regulation function.

This mode can be enabled via configuration software. It is enabled by default in some regions, such as AU, DE market. For information on how to change default setpoints please contact Slenergy Technical Support at service@Slenergy.com.

Descriptions of reactive power regulation mode:

Mode	Descriptions
Off	The PF is fixed at +1.000.
PF	The reactive power can be regulated by the parameter PF (Power Factor).
Qt	The reactive power can be regulated by the parameter fixed Q(in Pn%).
Q(P)	The PF changes with the output power of the inverter.
Q(U)	The reactive power changes with the grid voltage.

Off - Modes

The reactive power regulation function is disabled. The PF is limited to +1.000.

PF - Mode

The power factor is fixed and reactive power setpoint is calculated according to the current power. The PF ranges from 0.8 leading to 0.8 lagging.

Leading: the inverter is sourcing reactive power to the grid.

Lagging: the inverter is injecting reactive power into the grid.

Qt - Mode

In the Qt mode, system rated reactive power is fixed, and the system injects reactive power according to the delivered reactive power ratio.

The setting range of the reactive power ratio is 0~60% or 0~-60%, corresponding to the ranges of inductive and capacitive reactive power regulation respectively.

Q(P) - Mode

The PF of the inverter output varies in response to the output power of the inverter. "Q(P)" Mode Parameter Descriptions :

Parameter	Explanation	Range
QP_P1	Output power at P1 on the Q(P) mode curve (in percentage)	10% ~ 100%
QP_P2	Output power at P2 on the Q(P) mode curve (in percentage)	20% ~ 100%
QP_P3	Output power at P3 on the Q(P) mode curve (in percentage)	20% ~ 100%
QP_K1	Power factor at P1 on the Q(P) mode curve	0.8 ~1
QP_K2	Power factor at P2 on the Q(P) mode curve	
QP_K3	Power factor at P3 on the Q(P) mode curve	
QP_Enter-Voltage	Voltage percentage for Q(P) function activation	100% ~ 110%
QP_Exit-Voltage	Voltage percentage for Q(P) function deactivation	90% ~ 100%
QP_Exit-Power	Power percentage for Q(P) function deactivation	1% ~ 20%
QP_Enable-Mode	Unconditional activation/deactivation of Q(P) function	Yes / No



Figure 71.6-2 Q(P) Curve

Q(U) - Mode

The reactive power output of the inverter will vary in response to the grid voltage. “Q(U)” Mode Parameter Descriptions :

Parameter	Explanation	Range
Hysteresis Ratio	Voltage hysteresis ratio on the Q(U) mode curve	0 ~ 5%
QU_V1	Grid voltage limit at P1 on the Q(U) mode curve	80% ~ 100%
QU_Q1	Value of Q/Sn at P1 on the Q (U) mode curve	-60% ~ 0
QU_V2	Grid voltage limit at P2 on the Q(U) mode curve	80% ~ 110%
QU_Q2	Value of Q/Sn at P2 on the Q (U) mode curve	-60% ~ 60%
QU_V3	Grid voltage limit at P3 on the Q(U) mode curve	100% ~120%
QU_Q3	Value of Q/Sn at P3 on the Q (U) mode curve	-60% ~ 60%
QU_V4	Grid voltage limit at P4 on the Q(U) mode curve	100% ~120%
QU_Q4	Value of Q/Sn at P4 on the Q(U) mode curve	0 ~ 60%
QU_Enter-Power	Active power for Q(U) function activation	20% ~ 100%
QU_Exit-Power	Active power for Q(U) function deactivation	1% ~ 20%
QU_Enable-Mode	Unconditional activation/deactivation of Q(U) function	Yes/No/Yes, Limited by PF

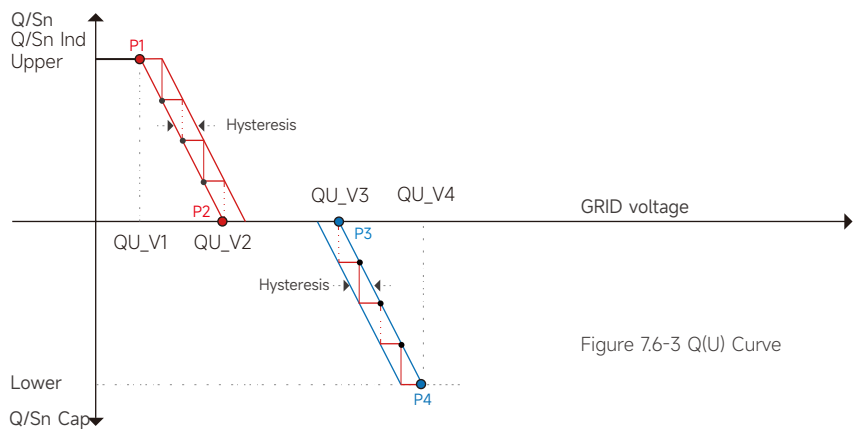
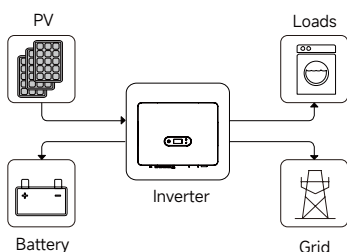

Figure 7.6-3 Q(U) Curve

7.7 Operation mode

General Mode



In this working mode, when the power from the PV array is sufficient, PV power will supply the loads, battery, and grid in the order of loads first, battery second, and grid last.

(You can set the power to the grid to 0W when the local grid doesn't allow inverter power to feed to the grid).

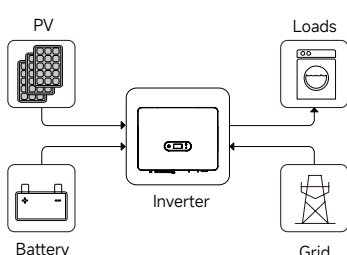

When the PV power is insufficient, the battery will discharge to supply loads, and the grid will join in if the battery is not enough to supply loads.

Peak load Shifting (Load Shifting)

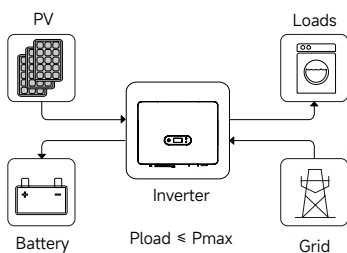

Set the maximum power Pmax (kVA) contracted with the grid.

When the load consumption is less than the Pmax, the PV will charge the battery first, and the grid supplies the load. When the battery is full, PV will supply the load together with the grid, but the battery doesn't.

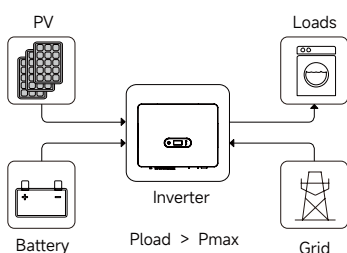

When the load consumption exceeds the Pmax, the inverter will take power from the battery and PV to supply power to the load to compensate for the power that exceeds the Pmax.

*To realize the "Peak load Shifting" function, the load power that exceeded Pmax has to be within the inverter max output power, otherwise, the inverter will only output the max power which allowed.

Economic Mode

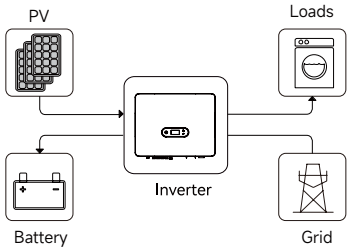

In this working mode, you can set charge/discharge power and time in the App, inverter will use the power from PV or grid (whether to use can be set in the App) to charge the battery in the predetermined period.

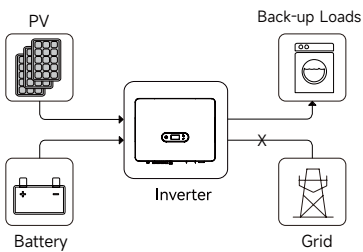

Inverter will use power from PV and battery to supply loads in the predetermined period and the insufficient part will be supplied by the grid.

Off-grid Mode

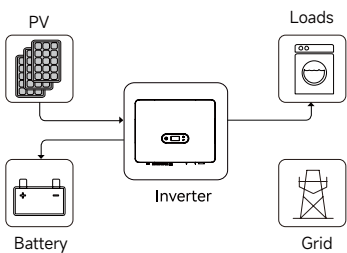

In the purely off-grid mode, power from PV will supply the back-up loads first and then charge the battery if there's surplus power.

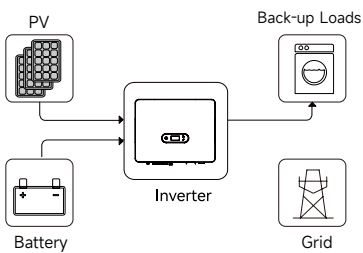

When the power from PV isn't enough, the battery will discharge to supply back-up loads together with PV.

8

Monitoring

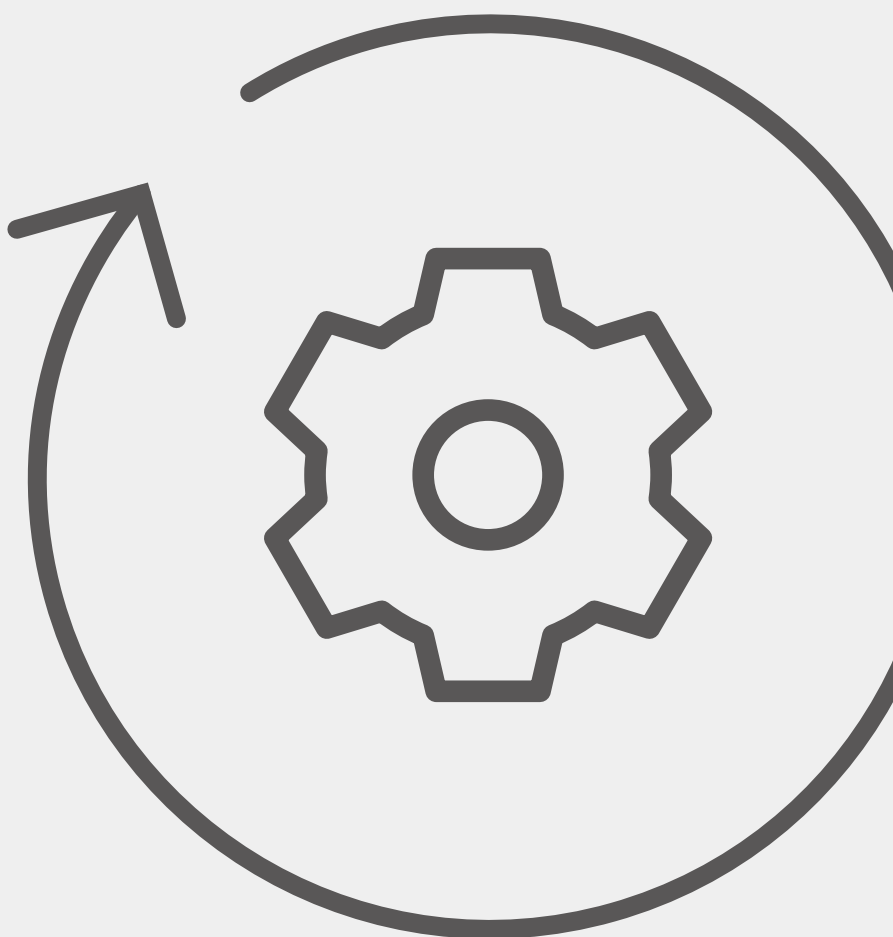

8.1 Inverter Monitoring

8.1.1 Monitoring Device

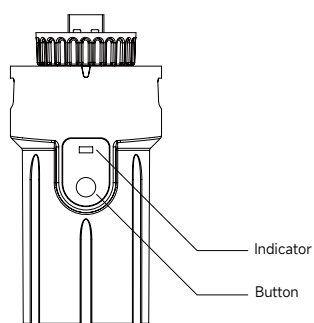

Figure 8.1.1-1
Monitoring device display interface

Indicator Status	Description
Off	Connection abnormal
Always On	Communicate with the server normally
Slow flashing	The monitoring device is not connected to the router or is not connected to the base station.
Quick flashing	The monitoring device is connected to the router or connected to the base station but not connected to the server.

Button	Description
Press 1 second	Reset device, the indicator goes off for 2 seconds, then flashes normally.
Press 5 seconds	Restore factory default settings, the indicator goes off for 2 seconds, then flashes once every 2 seconds, until the factory restore is completed.

NOTE

The WiFi module needs to be configured to the router for the first installation. If the router name or password are changed, the WiFi devices will need to be reconfigured. For details, please refer to the [QUICK USE GUIDE] which is attached to the accessory bag.

If DHCP is enabled on the router, the LAN version module does not need to be configured. Otherwise, please refer to the [QUICK USE GUIDE] which is attached to the accessory bag.

8.1.2 Cloud monitoring App

Slenergy inverter provides a monitoring port that can collect and transmit data from the inverter to Slenergy monitoring platform via an external monitoring device. Please refer to the product nameplate on side of enclosure to get the monitoring application. If download issues exist, contact your dealer or Slenergy technical support.

8.1.3 Local configuration App

Local configuration App is designed for quick configuration of Slenergy hybrid inverters, offering features such as safety code, battery brand and type, work modes, and off-grid application settings through WiFi direct connection, etc.

Please refer to the product nameplate on side of enclosure to get the application. If download issues exist, contact your dealer or Slenergy technical support.

8.2 Battery LED indication

LED status

Battery Status	Protection, alarm normal	LED status		Capacity				Description
		RUN	ALM	●	●	●	●	
Off		Off	Off	Off	Off	Off	Off	ALL OFF
On	Normal	Flash 1	Off	Based on capacity				No charging or discharging
	Warning	Flash 1	Flash 3					PACK low voltage
Charge	Normal	ON	Off	Based on capacity, the highest level LED flashes (flash 2), the other SOC lights is on all the times.				
	Warning	ON	Flash 3					
	Over Charge	On	Off	On	On	On	On	Stop charging
	Over Temp/Current Failure	Off	ON	Off	Off	Off	Off	
Discharge	Normal	Off	Flash 3	Based on capacity, the highest-level LED flashes, the other SOC lights is on all the times.				
	Warning	Flash 3	Flash 3					
	Over Discharge	Off	Off	Off	Off	Off	Off	Stop discharging
	Over Temp/Current Failure	Off	On	Off	Off	Off	Off	
Failure		Off	On	Off	Off	Off	Off	Stop charging and discharging

SOC status

Status	Charge				Discharge				
	L1	L2	L3	L4	L1	L2	L3	L4	
Capacity	0~25%	Flash 2	Off	Off	Off	On	Off	Off	Off
	25%-50%	On	Flash 2	Off	Off	On	On	Off	Off
	50%-75%	On	On	Flash 2	Off	On	On	On	Off
	75%-100%	On	On	On	Flash 2	On	On	On	On
Run	On					Flash 3			

Flash description: Flash 1: 0.25s on/3.75s off

Flash 2: 0.5s on/0.5s off Flash 3: 0.5s on/1.5s off

9

Maintenance & Troubleshooting



9.1 Maintenance and troubleshooting of PV modules

Module need to be inspected and maintained on a regular basis, especially during the warranty period. The following maintenance measures are recommended to ensure optimal performance of the module:

9.1.1 Visual inspection

- It is recommended to perform a preventive inspection for 6 months without replacing the module of the module. If electrical or mechanical performance inspection or maintenance is required, it is recommended that qualified personnel perform the operation to avoid electric shock or personal injury.
- The borderless single glass corner protector is used as the transportation protection part, and the appearance control is not performed. The customer chooses to disassemble or retain it.
- Check if the module glass is damaged.
- Confirm if there is a sharp object touching the surface of the module.
- Check if the module is blocked by obstacles or foreign objects.
- Check if the module terminals are disconnected.
- Confirm the rupture caused by unmanned surface of the module.
- Check the fixing screws between the module and the bracket for looseness or damage, and adjust or repair them in time.

9.1.2 Connector and cable inspection

- It is recommended to perform a preventive check every 6 months and check all cables to verify that they are securely connected; Avoid directing the cable from direct sunlight and away from the water. Keep the connector dry and clean. Make sure the connector's nut is tightened before connecting. Do not connect the connector while the connector is wet, dirty, or otherwise.
- Check the sealant at the junction box for cracks, gaps, and signs of aging of the PV modules. This includes possible rodent damage, weathering, and the tightness and corrosion of all connectors. Check that the modules are well grounded
- It is recommended that the torque of the terminal bolts and all aspects of the wiring be checked at least once a year. Also, check that the installed hardware is securely in place. Loose connections can cause arcing and electric shocks that can damage the array.

9.1.3 Cleaning

The accumulation of dust in the air on the glass surface of the assembly reduces its power output and performs cleaning as often as possible (as for the frequency of cleaning, depending on the conditions at the installation site). Wipe the PV module with a dry or damp soft and clean cloth when cleaning. Do not use corrosive solvents or wipe the PV module with a hard object.

- Under no circumstances should the surface be cleaned with a rough surface.
- The back of the assembly usually does not need to be cleaned. However, when it is deemed necessary to clean it, avoid using any sharp objects that may cause damage or penetrate the substrate material.
- Do not attempt to clean PV modules that have broken glass or exposed wires, which pose a risk of electric shock.
6.3.1 Water quality requirements PH: 5~7; Chloride or salt content: 0~3,000 mg/L Turbidity: 0~30 NTU Conductivity: 1500~3000 $\mu\text{s}/\text{cm}$ Total dissolved solids: ≤ 1000 mg/L Water hardness: 0~40 mg/L Non-alkaline water must be used, and demineralized water is used when conditions are met. 6.3.2 Component inspection after cleaning.
- The overall appearance of the visual components is clean, bright and free of stains. Sampling checks for the presence of ash on the surface of the component. There are no obvious scratch marks on the surface of the component. There is no rupture caused by the surface of the component.
- Whether the component bracket is tilted or bent after cleaning. Whether the component terminals are disconnected or the like.
- After the PV modules are cleaned, the PV module cleaning records are completed.

9.1.4 Troubleshooting

If it does not work properly after installation, please notify the installer immediately.

9.2 Maintenance and troubleshooting of inverter

9.2.1 Maintenance of inverter



Incorrect operation does cause the risk of inverter damage or personal injury. Please strictly follow the steps below.

- Select ' stop' option on inverter screen or monitoring app to shut down inverter.
- Turn off the AC breaker on utility grid side.
- Turn off inverter DC switch.
- Turn off the battery switch, and disconnect the DC breaker on the battery side (if any).
- Wait for 10 minutes to ensure the energy of capacitor is fully dissipated.
- Confirm all the indicator lights are off.



Keep unprofessional person away.

A temporary alarm sign or barrier must be posted to keep unprofessional person away while performing electrical connection and maintenance.



Any Arbitrary replacement of internal components is forbidden. Please seek help from installer or Slenergy for maintenance support. Otherwise, we will not take any responsibility.



Please remember not to do the self-maintenance before being familiar with the proper instruction of the whole process.

Items	Methods	Period
System clean	Check dust or foreign matter on the heat-sink, air inlet and outlet.	Once 6-12 months
Electrical connection	Check whether the cables are in good connection.	
Sealing	Check whether all the terminals and ports are properly sealed. Reseal the cable hole if it is aging or not sealed.	Once a year

9.2.2 Troubleshooting of inverter

9.2.2.1 Error Message

SL-D4~20KTR series hybrid inverter is designed in accordance with grid operation standards, and conform to the requirements of safety and EMC. The inverter had passed a series of rigorous tests to ensure it runs sustainably and reliably before shipment.

When a fault occurs, the corresponding error message will be shown on the OLED display, and in this case, the inverter might stop feeding into grid. The fault messages and their corresponding troubleshooting methods are listed below:

Error Message	Description	Solution
Mains Lost	Grid power outage, AC switch or circuit is disconnected.	<ol style="list-style-type: none"> 1. Check whether the mains supply is lost. 2. Check whether the AC breaker and terminal are well connected.
Grid Voltage Fault	Inverter detects that the grid voltage exceeds the limit of selected safety set range.	<ol style="list-style-type: none"> 1. Check whether the safety code is correct. 2. Check whether the AC cable wiring is correct. 3. Check whether the voltage increased cause by large AC cable impedance. In this case we could replace with a thicker AC cable. 4. Extend the voltage protection limit with the permission of the Electricity Authority.
Grid Frequency Fault	Grid over frequency or underfrequency, the grid frequency is higher or lower than the set protection value.	<ol style="list-style-type: none"> 1. Check whether the AC cable is correct and well connected. 2. Change to another country with wider protection range if it's allowed by the local electricity company.
DCI Fault	Inverter detects that the the direct current injection value exceeds the range.	<ol style="list-style-type: none"> 1. Restart the inverter. 2. Seek for help from the installer or manufacture.
ISO Over Limitation	Inverter detects that DC side's insulation impedance to the ground is too low.	<ol style="list-style-type: none"> 1. Check whether PV panels, cables, and connectors are waterlogged or damaged. 2. Use a megger to measure ground resistance on the DC sidel, and the measured value should not be less than 500 KΩ. 3. Seek help from the installer or manufacture.
GFCI Fault	The inverter detects that the ground leakage current exceeds the limitation.	<ol style="list-style-type: none"> 1. Restart the inverter. 2. Check whether the PV panels, cables, and connectors are waterlogged or damaged. 3. Seek help from the installer or manufacture.
PV Over Voltage	PV input voltage exceeds the upper limit.	Reduce the number of PV panels to make sure that the open-circuit voltage of each string is lower than the inverter maximum allowed input voltage.
Bus Voltage Fault	The voltage of bus circuit is too high	<ol style="list-style-type: none"> 1. Check whether the input voltage exceeds the limit. 2. Restart the inverter. 3. Seek help from the installer or manufacture.
Inverter Over Temperature	The inverter detects its high internal temperature	<ol style="list-style-type: none"> 1. Check whether the inverter installation location is well ventilated. 2. Try to turn it off for a while, and then power it back on when it cools down. 3. Seek help from the installer or manufacture.



Error Message	Description	Solution
N-PE Check Fault	The ground cable is loosed or in poor connection	Check whether the ground cable wiring is correct.
SPI Fault	Internal communication got failed. Caused by a strong external magnetic field etc.	1. Restart the inverter. 2. Seek help from the installer or manufacture.
E2 Fault	Internal storage got abnormal. Caused by a strong external magnetic field etc.	1. Restart the inverter. 2. Seek help from the installer or manufacture.
GFCI De vice Fault	GFCI device got abnormal	1. Restart the inverter. 2. Seek for help from the installer or manufacture.
AC Transducer Fault	AC transducer got abnormal	1. Restart the inverter. 2. Seek for help from the installer or manufacture.
Relay Check Fail	Self-checking of internal relay got failed. Neutral & ground cable are in poor connection on AC side.	1. Use multimeter to measure the voltage between N&PE cable on AC side. If the voltage is higher than 10V, which means the neutral or ground connection is abnormal. 2. restart the inverter. 3. Seek help from the installer or manufacture.
Internal Fan Fault	Inverter's internal fan got failed	1. Restart the inverter. 2. Seek for help from the installer or manufacture.
External Fan Fault	Inverter's external fan got failed	1. Check whether the fan is blocked by foreign matters, clean them if necessary.
Bat OV	Battery protection got triggered	1. Check working status of battery. 2. Check if battery is alarming.
Backup OV	Abnormal voltage exists on the back-up side	Turn off inverter and remove the back-up connector. Use a multimeter to measure whether there is voltage existing on the back-up connector.
Bus Volt Low	Abnormal power scheduling	Check whether the battery voltage or PV input voltage is normal
Hard Fault	Hardware protection got triggered	1. Restart the inverter. 2. Seek help from the installer or manufacture.
Backup OP	Output power over limitation on back-up side	Check whether the load power on back-up side exceeds the maximum output power of inverter.
Inverter OV	The load power exceeds the range of its limit of inverter in off-gird mode	1. Check whether there is an impact load on the back-up side and whether the load power is too high. 2. Check whether back-up side is short circuit.
Inverter OF	The load power exceeds the range of its limit of inverter in off-gird mode	1. Check whether there is an impact load on the back-up side and whether the load power is too high. 2. Check whether back-up side is short circuit.
Inverter OC	The load power exceeds the range of its limit of inverter in off-gird mode	1. Check whether there is an impact load on the back-up side and whether the load power is too high. 2. Check whether back-up side is short circuit.
SCI Fault	Internal communication got failed. Caused by a strong external magnetic field etc.	1. Restart the inverter. 2. Seek for help from the installer or manufacture.
FLASH Fault	Internal storage anomaly. Caused by a strong external magnetic field etc.	1. Restart the inverter. 2. Seek for help from the installer or manufacture.
Meter Comm Fault	Abnormal communication between meter and inverter.	1. Check whether the communication connection between inverter and meter is reliable 2. Confirm whether the meter model is compatible
BMS Comm Fault	Abnormal communication between inverter and battery BMS.	1. Check whether the battery ID selection is correct. 2. Check whether the communication connection between inverter and BMS is reliable 3. Check the working status of battery

9.3 Maintenance and troubleshooting of Battery

9.3.1 Maintenance of electrical components

Item	Project	Checkpoint	Methods	Repair condition	
1	Electrical	Check whether the voltage output is normal.	Multi-meter	The battery voltage exceeds the preset range	Contact the dealer or manufacturer.
2	Failure to check	Check whether the light is normal.		Warning	
3	Cable	Insulation, terminal	Visual inspection	Insulation crack, aging, the terminal is peeling or corroded.	Replace the cable, replace the terminal board.

9.3.2 Battery Maintenance

Installation and maintenance of batteries should be performed or supervised with professional knowledge about batteries.



- Do not dispose battery in fire, or it may explode.
- Do not dismantle or break the battery. The electrolyte inside would be harmful to your body.

The battery has risk of electrical shock, the following scenario should be noticed during the operation:

- Remove metal items from your body.
- Use insulated tools.
- Remove metal items from battery.
- Turn off the DC breaker of the battery before assembling or disassembling battery terminals.
- There is a risk of electrical shock if battery is unexpectedly grounded. Remove the grounding cable to avoid the electrical shock.



Risk of battery damage or personal injury due to incorrect service!

Keep non-qualified persons away!

Restart the battery only after removing the fault that impairs safety performance. Never arbitrarily replace any internal components. For any maintenance support, please contact Slenergy. Otherwise, Slenergy shall not be held liable for any damage caused.

Servicing of the device in accordance with the manual should never be undertaken in the absence of proper tools, test equipment or the latest revision of the manual which has been clearly and thoroughly understood.

Item	Frequency	Project	Solution
1		Working environment	Keep away from heat sources and direct sunlight.
2	Every month	Visual inspection	If there is damage, leakage or deformation, isolate the faulty battery pack, take photos and replace the battery.
3		Visual inspection	Clean appearance with cotton cloth. Be careful when cleaning.
4	Every quarter	Connection status	Check whether the wiring is tight, check the temperature of the wire.
5	Half a year	Measure and record voltage	Collect discharge data at least once every six months in the first year. In the second year, discharge data were collected every three months. Check the historical records through the RS232 port. If the alarm information shows that the battery is frequently overcharged, the battery has reached the charging and discharging protection points. This may lead to insufficient time for power preparation. It is recommended to replace the battery immediately.

9.4 Maintenance and troubleshooting of Mounting structure

In order to ensure the reliable operation of the solar mounting structure and improve the safety of the equipment, a daily patrolling inspection system should be established in the daily operation and maintenance work. Patrolling inspection should be conducted at least once every month. The purpose of inspection work is to discover hidden troubles in time, prevent them before occurrence, and effectively improve the reliability of solar mounting structure.

Please take note that after severe conditions such as strong winds above level 6, tropical storms, heavy snow weather and earthquakes etc., maintenance and repair personnel should be organized to conduct a thorough inspection of the solar mounting structure and write down corresponding inspection records. If the solar mounting structure is found to be damaged, it should be reported immediately for the handling of issues.

Check whether there is rubbish or debris on the surface; check whether the entire structure of the solar mounting system is corroded, or any part is missing or falling off; pay attention to the sealing tightness of places where they have been sealed, and repair if necessary.

When the height of solar mounting structure exceeds 2.5m, the dressing of the climber shall meet the climbing requirements. They should be equipped with safety belts before installation. All on-site maintenance and inspection personnel must wear safety helmets and other protective equipment. Maintenance and inspection work are prohibited when there are strong winds above grade 4, there is rain and snow weather or there are no night-time construction lighting facilities in the evening. Maintenance and inspection personnel are strictly prohibited from smoking and drinking during installation time.



**Easy Energy
Easy Life**

